

**DIGITAL**  **PROJECTION**

A Delta Associate Company

# *E-Vision Laser 5100 Series*

High Brightness Digital Video Projector

INSTALLATION & QUICK START GUIDE

CONNECTION GUIDE

OPERATING GUIDE

REFERENCE GUIDE



## About this document

Follow the instructions in this manual carefully to ensure safe and long-lasting use of the projector.

### Symbols used in this document

Many pages in this document have a dedicated area for notes. The information in that area is accompanied by the following symbols:



**LASER WARNING:** this symbol indicates that there is a potential hazard of eye exposure to laser radiation unless the instructions are closely followed.



**ELECTRICAL WARNING:** this symbol indicates that there is a danger of electrical shock unless the instructions are closely followed.



**WARNING:** this symbol indicates that there is a danger of physical injury to yourself and/or damage to the equipment unless the instructions are closely followed.



**NOTE:** this symbol indicates that there is some important information that you should read.

### Product revision

Because we at Digital Projection continually strive to improve our products, we may change specifications and designs, and add new features without prior notice.

### Additional Documentation

Updates to this manual may be available online.

Please use the QR code (also located on the projector) to access the latest E-Vision projector user guides and other documentation via the Digital Projection website.



Or visit the products specification page on the Digital Projection website to download the latest user guide and other documentation.

### Legal notice

Trademarks and trade names mentioned in this document remain the property of their respective owners. Digital Projection disclaims any proprietary interest in trademarks and trade names other than its own.

Copyright © 2020 Digital Projection All rights reserved.

**Notes**

**Electrical and Physical Specifications**

Mains Voltage	100-240VAC 50/60Hz 5.3A
Operating Temperature	0°C to 40°C (32°F to 104°F)
Storage Temperature	-20°C to 60°C (-4°F to 140°F)
Operating Humidity	10% to 85% non-condensing
Storage Humidity	5% to 95% non-condensing
Dimensions	L:551mm (21.69in) X W: 461mm (18.14in) X H 285mm (11.22in)
Weight	11Kg (24.2lb) including lens
Power Consumption	at 100VAC: 500W typical (normal mode) at 240VAC: 480W typical (normal mode)
Standby Power	<2W (With LAN enabled), <0.5W (Without LAN enabled)
Thermal Dissipation	at 100VAC: 1706BTU/Hour typical (Normal mode) at 240VAC: 1638BTU/Hour typical (Normal mode)
Fan Noise	36dBA typical, 38dBA max (Normal mode)

 Specifications are subject to change without notice.

**Notes**

## Optical radiation

### Projector

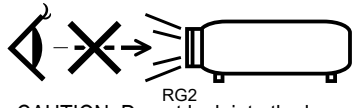

CAUTION: Do not look into the lens

#### CLASS 3R LASER PRODUCT

This Laser Product is designated as Class 3R during all procedures of operation.

**LASER LIGHT - AVOID DIRECT EYE EXPOSURE.**

Caution - possibly hazardous optical radiation emitted from this product. Direct or scattered light can be hazardous to eyes and skin.

Do not stare at operating light source.

Do not point laser or allow laser light to be directed or reflected toward other people or reflective objects.

There is a potential hazard of eye exposure to laser radiation if the included instructions are not followed.

Caution – use of controls or adjustments or performance of procedures other than those specified herein may result in hazardous radiation exposure.

Non-laser emission. There remains non-laser emission from the projection lens.

This projector is tested according to IEC/EN62471-5:2015 (Photobiological safety of lamps and lamp systems – Part 5: Image projectors standard) and is Risk Group 2 (low risk).



### Remote Control Unit - Presentation Laser Pointer

Caution - possibly hazardous optical Laser radiation emitted from this product.

Class 2 laser product.

Wave Length: 640-660nm. Max Output: less than 1 mW.

Do not stare into the beam.

Do not view directly with optical instruments.

Do not point laser or allow laser light to be directed or reflected towards people, animals, transportation or reflective objects.

Only allow use by responsible persons.

Keep out of reach of children.

This device is not a toy.



Notes

## Laser information



Caution - use of controls or adjustments or performance of procedures other than those specified herein may result in hazardous radiation exposure.

### Location of Laser Aperture

1. The laser aperture is located as indicated below.



Be careful not to expose the eye to direct laser light.

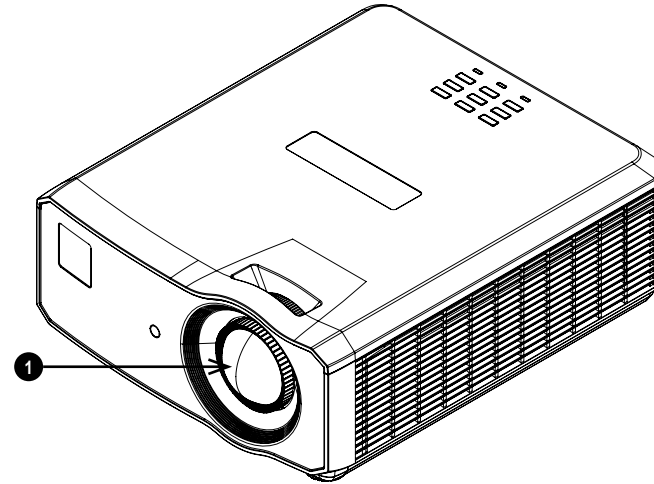

*Notes*

**Laser Parameters**

Wavelength	450-460nm (Blue)
Mode of operation	Pulsed, due to frame rate
Pulse duration	1.34ms
Pulse repetition rate	120Hz
Maximum pulse energy	0.698mJ
Total internal power	>100W
Apparent source size	>10mm, at lens stop
Divergence	>100 mili Radian

**Laser Pointer Parameters**

Wavelength	640-660nm
Max Output	<1mW

**Notes**

## Product Labels

## Projector

## Notes

**DIGITAL PROJECTION** DLP Projector / Projecteur  
(數位投影機 / 數字投影機)

Model Name / Modèle(型號 / 型号): E-Vision Laser 5100 WUXGA  
INPUT / Entrée(輸入 / 輸入): 100-240V ~ 50/60Hz 5.3A

This device complies with Part 15 of the FCC rules, Operation is subject to the following two conditions:  
(1) This device may not cause harmful interference, and  
(2) This device must accept any interference received, including interference that may cause undesired operation.  
CAN ICES-3(B) / NMB-3(B).

Caution: Do not open, No user serviceable parts inside.  
警告: 請勿打開外殼, 設備內無服務性維修之元件。  
警告: 請勿打開外殼, 設備內無服務性維修之元件。  
Cuidado: no abra la tapa. Ninguna parte interna es reparable por Usuario.  
Avertissement : ne pas ouvrir le couvercle. Le produit ne contient aucune pièce interne réparable par l'utilisateur.











Digital Projection Limited Made in China/製造地: 中國/製造地: 中国 3264663300 XXXXX XXXXX

Manufacturers ID Label

Complies with FDA performance standards for laser products except for deviations pursuant to Laser Notice No. 50, dated June 24, 2007



**LASER RADIATION**  
AVOID DIRECT EYE EXPOSURE  
CLASS 3R LASER PRODUCT  
Emitted wavelength : 450-460 nm  
Max. Pulse energy: 0.698 mJ, Pulse duration: 1.34 ms

雷射輻射 避免眼睛受到直接照射 3R類雷射產品  
波長: 450-460 nm  
最大脈衝能量: 0.698 mJ, 脈衝時間: 1.34 ms  
激光輻射 避免眼睛受到直接照射 3R類激光產品  
波長: 450-460 nm  
最大脈衝能量: 0.698 mJ, 脈衝時間: 1.34 ms

RAYONNEMENT LASER  
EXPOSITION DIRECTE DANGEREUSE POUR LES YEUX  
APPAREIL À LASER DE CLASSE 3R  
longueur d'onde : 450-460nm  
maximum énergie de impulsion : 0.698 mJ,  
durée de impulsion : 1.34 ms

GB 7247.1-2012 / IEC/EN 60825-1:2007

CLASS 1 LASER PRODUCT PRODUIT LASER DE CLASSE 1  
IEC/EN 60825-1:2014 IEC/EN 60825-1:2014

 3264663301

Explanatory Label



**LASER APERTURE**  
雷射輻射之孔徑  
激光輻射窗口  
**OUVERTURE LASER**

Laser Aperture Label

 E-Vision User Guides

Follow link for Projector Documentation  
Suivre le lien pour accéder à la documentation du projecteur  
Produktdokumentation finden Sie unter dem Link  
この二次元バーコードをスキャンしてプロジェクターのデータを取得してください  
请扫描条码来取得投影机的文件  
프로젝터 설명서를 보려면 링크를 관리하십시오

User Guides Label

Remote Control

Notes



**Remote Control Label**



**Label Locations**

1. Location of Hazard Warning Symbol and Laser Aperture Label on the body of the projector.
2. Location of Manufacturer's ID Label and Explanatory Label with Certification Statement and Risk Statement on the body of the projector.

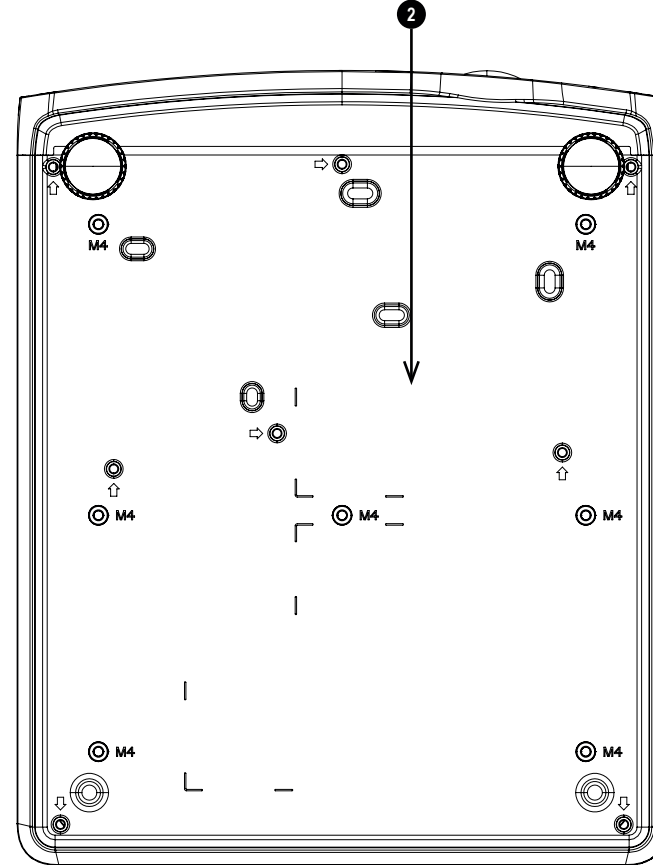
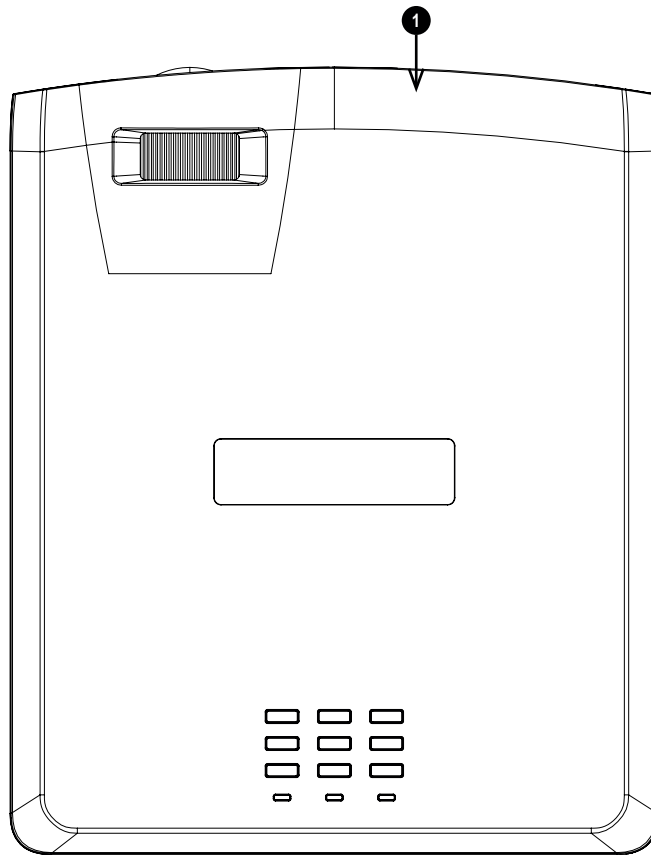

**Notes**

3. Location of Remote Control Label on the back of the remote.

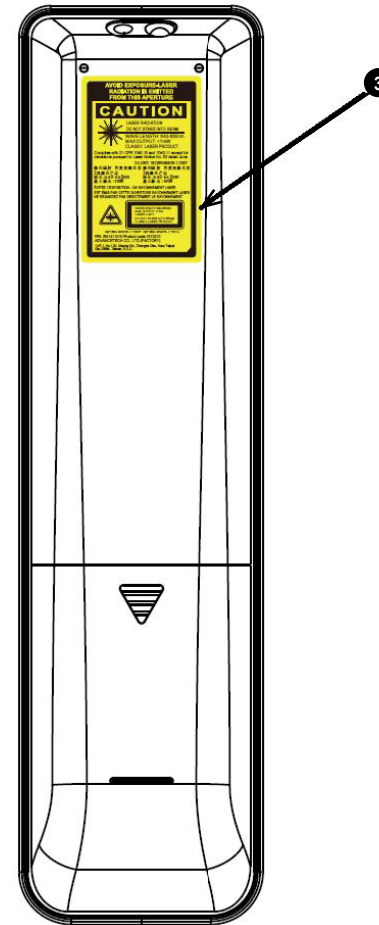

**Notes**

## Interlock Switches

Interlock switches are installed at the main frame, inside the cover. These will power-off the system individually when activated.

1. Will be activated when the top cover is removed.

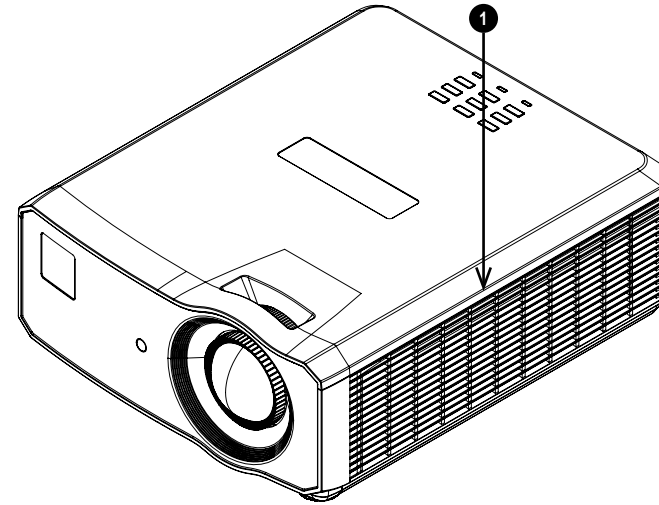

### Notes

## Introduction

### Notes

Congratulations on your purchase of this Digital Projection product. Your projector has the following key features:

- WUXGA native resolution delivering 5,100 ISO lumens.
- Up to 20,000:1 contrast ratio.
- Long life laser light source
- 24/7 Operation
- Rec 709 color gamut capability
- Support for Frame Sequential, Top and Bottom, Side-By-Side, and Frame Packing 3D.
- HDBaseT® for transmission of uncompressed High Definition Video up to 100 m from the source.
- Cornerstone, Vertical & Horizontal Keystone.
- Control via LAN and RS232.
- Constant brightness mode maintains light output at selected levels.
- Built in speakers

A serial number is located on the side of the projector. Please record it here for future reference:

**Contents**

**Notes**

**About this document** ..... **2**

*Symbols used in this document* ..... 2

*Product revision* ..... 2

*Additional Documentation* ..... 2

*Legal notice* ..... 2

**Electrical and Physical Specifications** ..... **3**

**Optical radiation** ..... **4**

*Projector* ..... 4

*Remote Control Unit - Presentation Laser Pointer* ..... 4

**Laser information** ..... **5**

*Location of Laser Aperture* ..... 5

*Laser Parameters* ..... 6

*Laser Pointer Parameters* ..... 6

**Product Labels** ..... **7**

*Projector* ..... 7

*Remote Control* ..... 8

*Label Locations* ..... 9

**Interlock Switches** ..... **11**

**Introduction** ..... **12**

**Contents** ..... **13**

**What's in the box?** ..... **16**

**Connecting the power supply** ..... **17**

**Projector overview** ..... **18**

**Control panel** ..... **19**

*Projector indicators* ..... 20

**Remote control** ..... **21**

*Infrared reception* ..... 24

**Positioning the screen and projector** ..... **25**

*Roll and pitch* ..... 26

**Operating the projector** ..... **27**

*Switching the projector on* ..... 27

*Switching the projector off* ..... 27

*Selecting an input signal* ..... 27

*Selecting a test pattern* ..... 27

*Adjusting the lens* ..... 28

*Adjusting the image* ..... 28

*Orientation* ..... 28

*Geometry* ..... 28

*Picture* ..... 28

*Adjusting the audio* ..... 29

**Signal inputs** ..... **32**

*Digital inputs and outputs* ..... 32

*EDID on the HDMI, and HDBaseT inputs* ..... 33

*Using HDMI / HDBaseT switchers with the projector* ..... 33

*Analog inputs and outputs* ..... 34

**3D connections** ..... **35**

*3D Sync* ..... 36

**Control connections** ..... **37**

*LAN connection examples* ..... 38

*RS232 connection example* ..... 39

**Using the menus** ..... **42**

*Opening the Menu* ..... 42

*Opening a submenu* ..... 42

*Exiting menus and closing the OSD* ..... 43

*Inside the Menu* ..... 44

*Accessing sub menus* ..... 44

*Editing projector settings* ..... 45

*Executing commands* ..... 45

*Using a slider to set a value* ..... 45

*Editing numeric values* ..... 46

**Using the projector** ..... **47**

*Image Menu* ..... 47

*Computer* ..... 48

*Advanced* ..... 48

*White Balance* ..... 49

*Color Manager* ..... 49

*Color manager parameters explained* ..... 50

*Settings 1 Menu* ..... 51

*Audio* ..... 51

*Alignment* ..... 52

*Keystone* ..... 52

*Keystone settings* ..... 53

*Keystone example* ..... 53

*4 Corner* ..... 54

*Advanced 1* ..... 55

*3D Setting* ..... 56

*3D types* ..... 57

*3D Sync Invert* ..... 57

*Advanced 2* ..... 57

*Settings 2 Menu* ..... 58

*Status* ..... 59

*Network* ..... 59

*Advanced 2* ..... 60

*Air Filter Settings* ..... 60

**Served web pages** ..... **61**

**Screen requirements** ..... **66**

*Fitting the image to the display* ..... 66

*WUXGA images displayed full width* ..... 66

*WUXGA images displayed with a height of 1200 pixels* ..... 66

*WUXGA images displayed full height* ..... 67

*Diagonal screen sizes* ..... 67

**Aspect ratios explained** ..... **68**

*Aspect ratios examples* ..... 68

*Source: 4:3* ..... 68

*Source: 16:9* ..... 69

*Source: 16:10 (native)* ..... 69

*Aspect ratio example: TheatreScope* ..... 70

**Appendix A: projector indicator messages** ..... **71**

**Vertical offset** ..... **72**

*Projection distance and size table* ..... 72

**Appendix B: supported signal input modes** ..... **73**

*2D formats* ..... 73

*3D formats* ..... 75

**Appendix C: wiring details** ..... **76**

*Signal inputs and outputs* ..... 76

*HDMI* ..... 76

*HDBaseT input* ..... 76

*VGA input* ..... 77

*Control connections* ..... 77

*LAN* ..... 77

*RS232* ..... 78

**Appendix D: glossary of terms** ..... **79**

**Notes**

**DIGITAL**   
**PROJECTION**

A Delta Associate Company

# *E-Vision Laser 5100 Series*

High Brightness Digital Video Projector

INSTALLATION & QUICK START GUIDE



**What's in the box?**

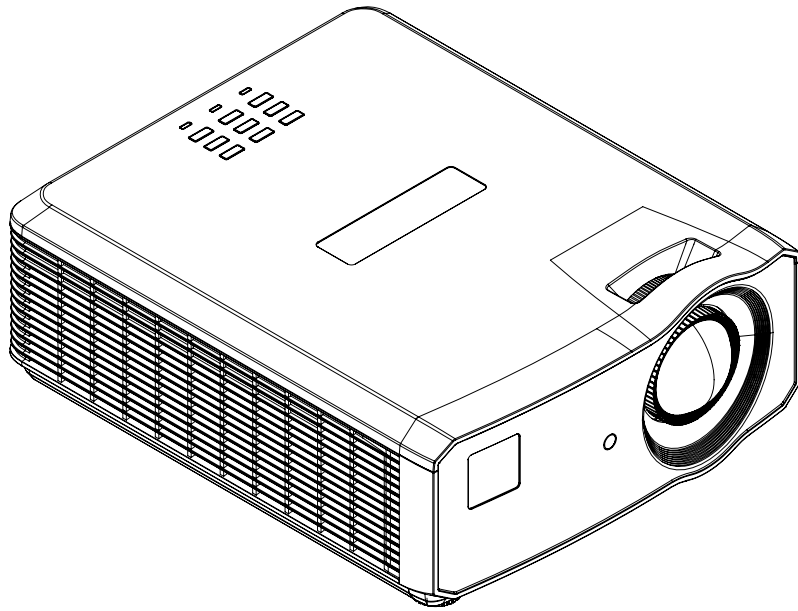

**Projector**



**Remote Control**

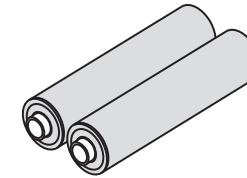

**Batteries (2xAAA)**

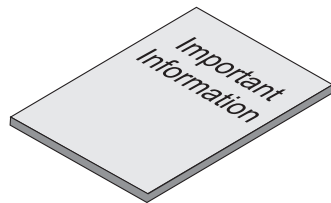

**Important Information Book**

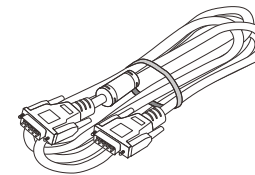

**VGA Cable**

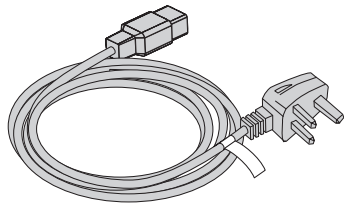

**Power Cable, UK**

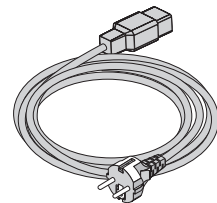

**Power Cable, Europe**

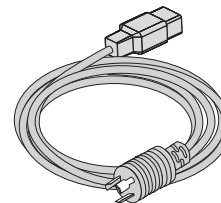



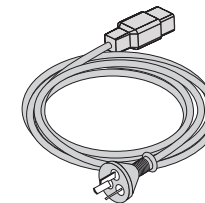

**Power Cable, North America**



**Power Cable, China**

**Notes**

-  *Make sure your box contains everything listed. If any pieces are missing, contact your dealer.*
-  *Only one remote is supplied with the projector.*
-  *Save and store the original box and packing materials, in case you ever need to ship your projector.*
-  *Only the appropriate cable for destination territory is supplied with the projector.*



## Connecting the power supply

1. Firmly push the mains connector into the AC In socket **1**

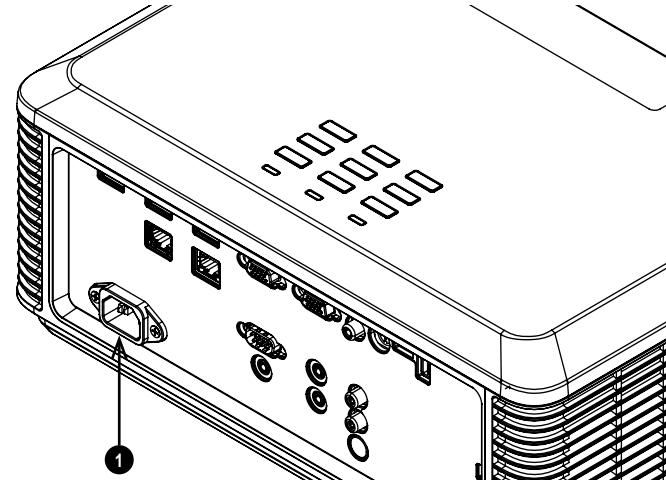

### Notes



Use only the power cable provided.



Ensure that the power outlet includes a ground connection as this equipment **MUST** be earthed.



Handle the power cable carefully and avoid sharp bends. Do not use a damaged power cable.

## Projector overview

1. Front infrared window
2. Focus control
3. Control panel
4. Indicators
5. Internal Speaker
6. Air inlet
7. Mains socket
8. Connections panel
9. Air outlet
10. Rear infrared window
11. Internal Speaker
12. Adjustable feet

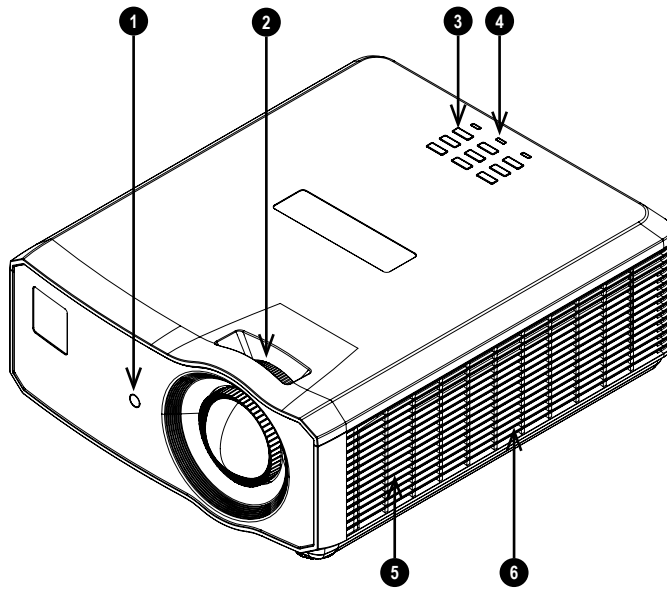

Front View

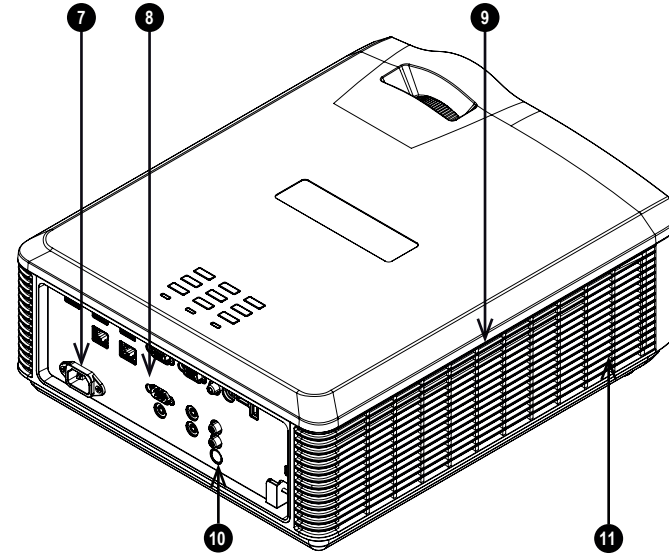

Rear View

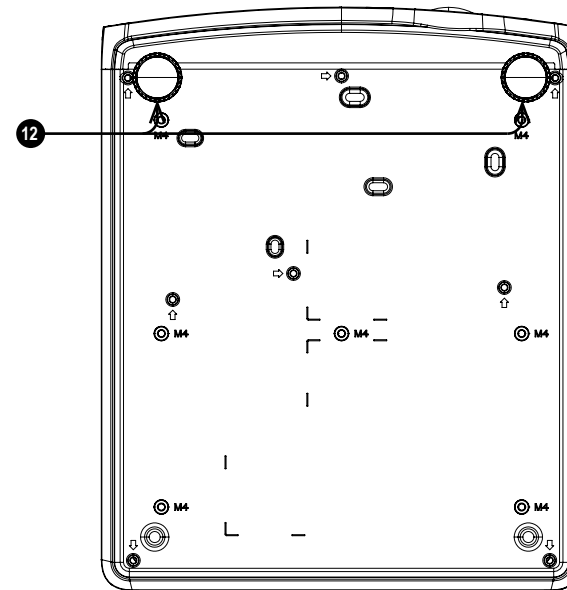

Bottom View

Notes

## Control panel

1. **AUTO**  
Optimizes the image size, position and resolution
2. **Arrow buttons & ENTER**  
Navigation buttons used to highlight menu entries in the OSD. Press **ENTER** to open or execute the highlighted menu entry.  
Adjusts keystone when OSD is off. Left and right adjust horizontal keystone, up and down adjust vertical keystone.
3. **SOURCE**  
Displays and exits the source menu
4. **POWER**  
Switches the projector on and off (STANDBY).
5. **MENU**  
Displays and exits the OSD.

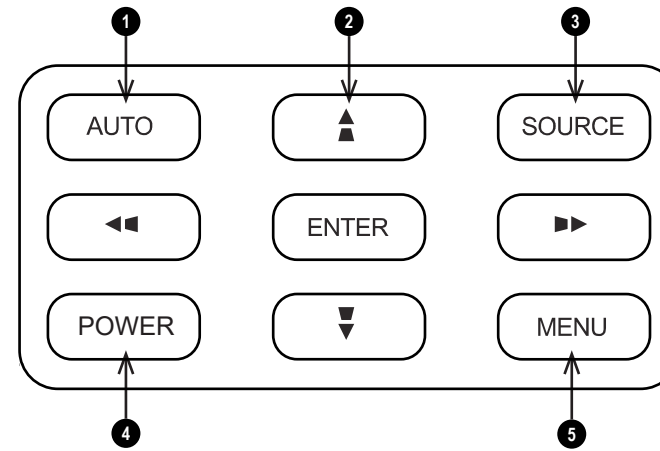

*Control Panel*

## Notes

### Projector indicators

- 1 POWER    On = projector is switched on  
              Flashing = starting up or cooling down
- 2 LIGHT    On = error
- 3 TEMP.    On = error

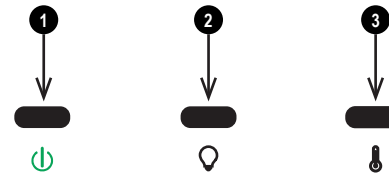

*Indicators*

**Notes**

## Remote control

1. **Power ON / OFF**  
Turns power on and off.
2. **PC**  
Select the Computer In input.
3. **HDMI**  
Select and toggle the HDMI 1, HDMI 2 or DVI-D input.
4. **USB**  
There is no USB function on this projector.
5. **Video S Video**  
Select the Video input.  
There is no S Video on this projector.
6. **Network**  
Open the Network menu in the OSD.
7. **HDBaseT**  
Select the HDBaseT input.
8. **MENU**  
Access the OSD. If the OSD is open, press this button to go back to the previous menu.
9. **Keystone adjust (arrows)/Navigation (arrows and return)**  
Adjust horizontal and vertical keystone.  
When the OSD is active, navigate through the menus with the arrows, confirm your choice with the return button.
10. **Keystone**  
Open the Keystone menu in the OSD.
11. **EXIT**  
Go up one level in the OSD. When the top level is reached, press to close the OSD.
12. **MHL**  
Enable the Mobile High-Definition Link technology feature for smart devices.

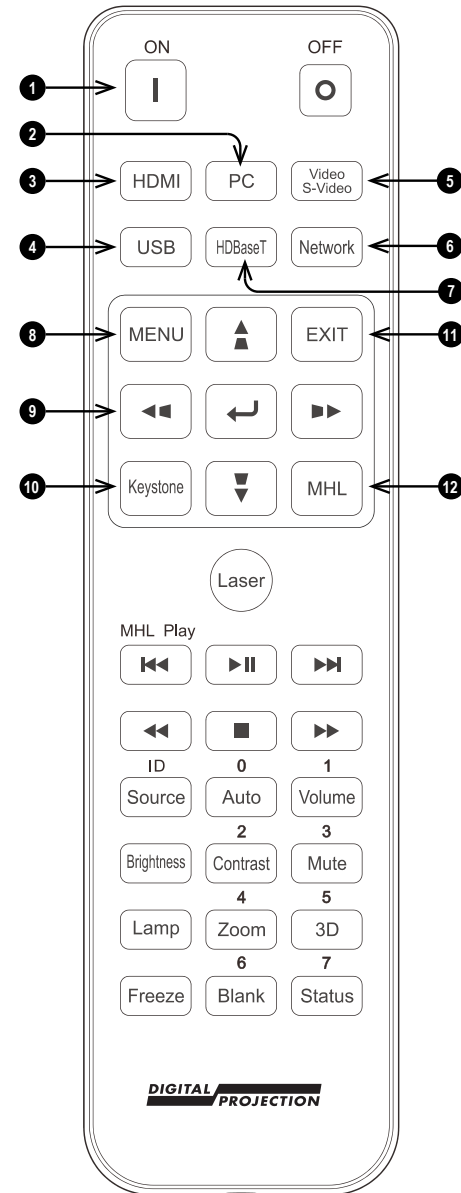

**Remote Control**

## Notes

 This projector does not use the following options on the remote:  
USB.  
S Video.

 The arrows, return and exit keys can be used to navigate an MHL device, when MHL is enabled.

- 13. **Laser**  
Enables the laser pointer.
- 14. **MHL Play controls**  
Play, pause, stop, rewind and fast forward MHL content.
- 15. **Auto / ID input 0**  
Automatically adjust frequency, phase and position.  
Use with **Source / ID** to set the remote ID to 0.
- 16. **Source / ID**  
Select the next input source.  
Use with a number key to set the remote ID.
- 17. **Volume / ID input 1**  
Open the Volume slider.  
Use with **Source / ID** to set the remote ID to 1.
- 18. **Contrast / ID input 2**  
Open the Contrast slider.  
Use with **Source / ID** to set the remote ID to 2.
- 19. **Brightness**  
Open the Brightness slider.
- 20. **Mute / ID input 3**  
Mute the audio output.  
Use with **Source / ID** to set the remote ID to 3.
- 21. **Zoom / ID input 4**  
Open the Zoom control.  
Use with **Source / ID** to set the remote ID to 4.
- 22. **Lamp**  
Open the light source options.
- 23. **3D / ID input 5**  
Open the 3D settings menu in the OSD.  
Use with **Source / ID** to set the remote ID to 5.

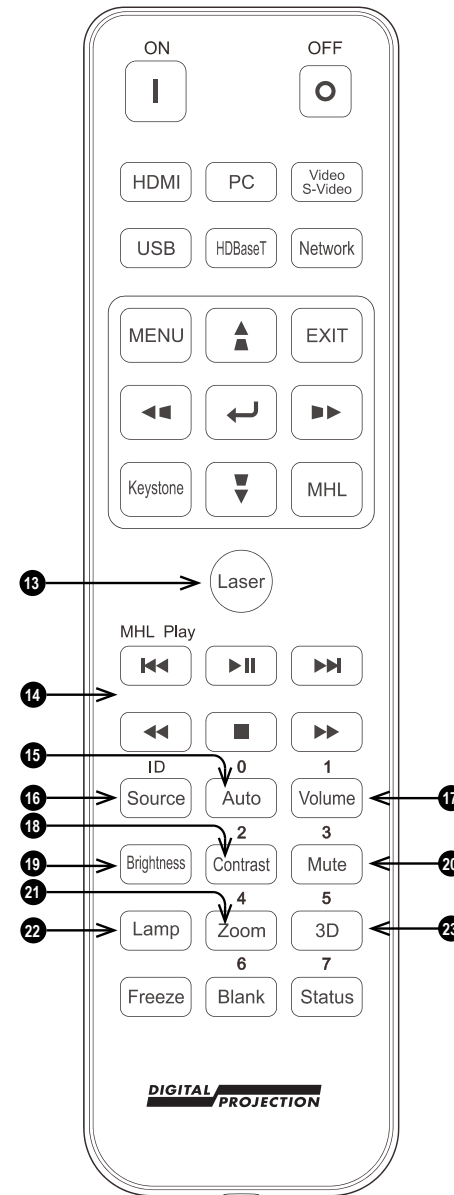

**Remote Control**

**Notes**



Do not point the laser pointer towards a persons eyes.

**24. Blank / ID input 6**

Shows and hides the projected image.

When blanking is enabled, the light source is completely switched off and the screen is blank.

Use with **Source / ID** to set the remote ID to 6.

**25. Freeze**

Freeze the current frame.

**26. Status / ID input 7**

Open the Status menu in the OSD.

Use with **Source / ID** to set the remote ID to 7.

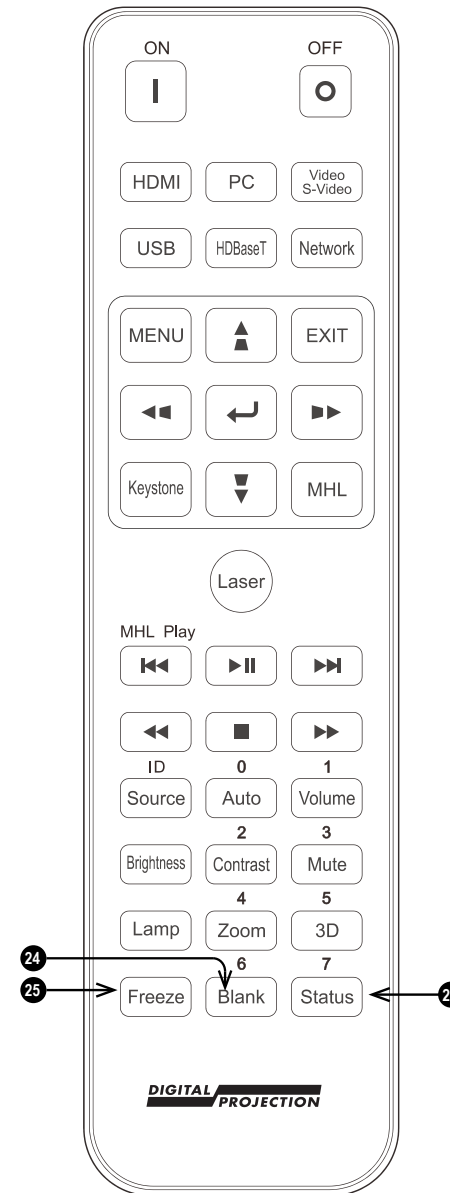
**Remote Control****Notes**

## Infrared reception

The projector has infrared sensors at the front and rear.

The remote control uses infrared transmission to control the projector. It is not necessary to point the remote control directly at the projector.

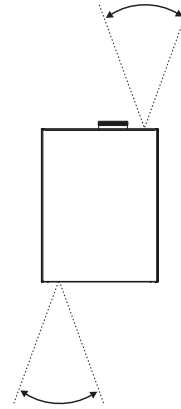

### Notes



*Avoid using the projector with bright fluorescent lighting turned on. Certain high-frequency fluorescent lights can disrupt the Infrared remote control operation.*



*Ensure nothing obstructs the path between the remote control and the projector. If the path between the remote control and the projector is obstructed, you can bounce the Infrared signal off certain reflective surfaces such as projector screens.*



*The buttons and keys on the projector have the same functions as the corresponding buttons on the remote control. This user's manual describes the functions available from the remote control.*



## Positioning the screen and projector

1. Install the screen, ensuring that it is in the best position for viewing by your audience.
2. Mount the projector, ensuring that it is at a suitable distance from the screen for the image to fill the screen. Set the adjustable feet so that the projector is level, and perpendicular to the screen.

The drawing shows the positions of the feet for table mounting, and the fixing holes for ceiling mounting.

1. Two adjustable feet
2. **Seven M4 holes for ceiling mount.** The screws should not penetrate more than 8 mm into the body of the projector.

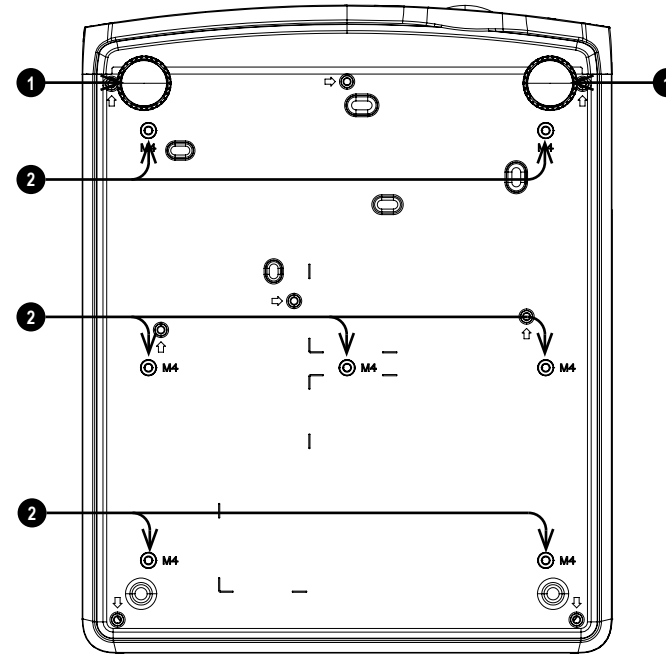

### Notes



Always allow the projector to cool for 5 minutes before disconnecting the power or moving the projector.



Ensure that there is at least 50 cm (19.7 in) of space between the ventilation outlets and any wall, and 30 cm (11.8 in) on all other sides.



Do not use the threaded holes for the adjustable feet to hang or mount the projector.

## Roll and pitch

The projector can be operated in numerous positions.

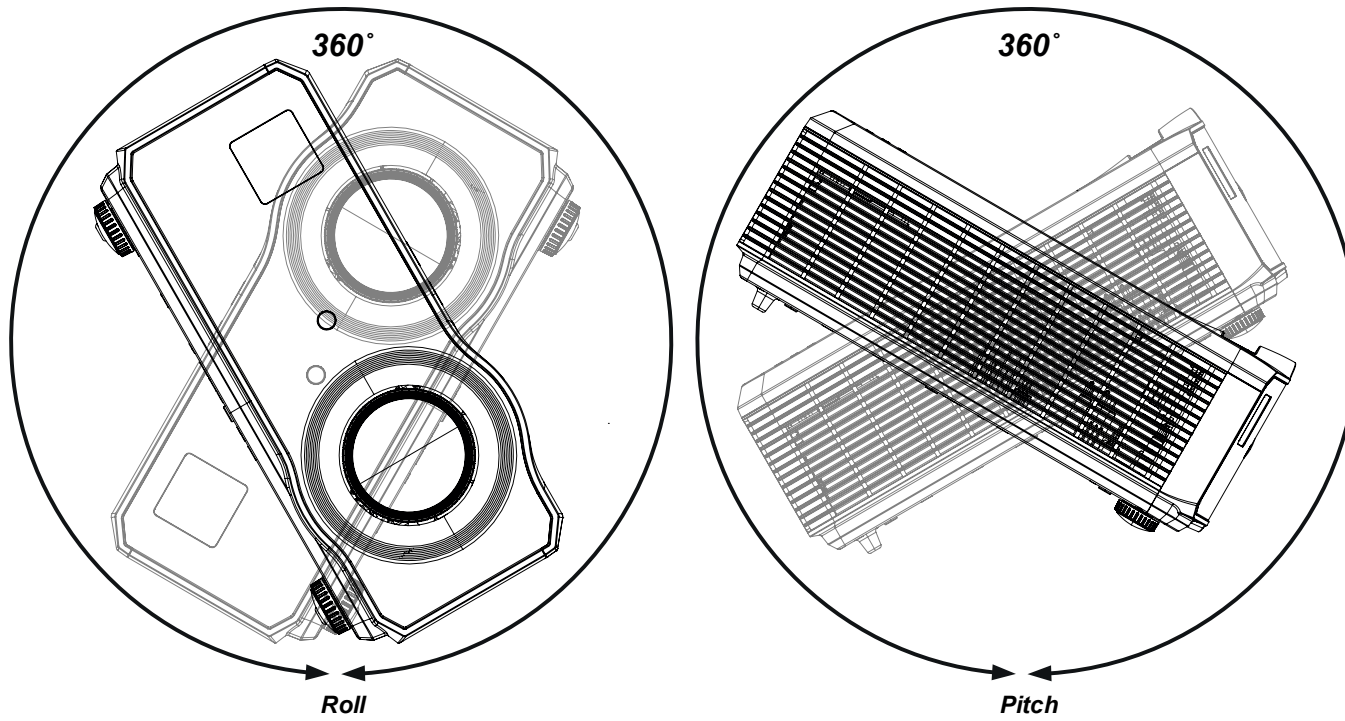

**Notes**

## Operating the projector

### Switching the projector on

1. Connect the power cable between the mains supply and the projector.  
The **POWER** indicator lights green to indicate that the projector is in STANDBY mode.
2. Press one of the following buttons:
  - On the remote control, the **ON** button
  - On the projector control panel, the **POWER** button.

The **POWER** indicator begins flashing green. In approximately 20 seconds, the startup screen appears. The projector is now switched on.

### Switching the projector off

1. Press **OFF** on the remote control or **POWER** on the control panel, then press again to confirm your choice.  
The **POWER** indicator on the control panel will start flashing green, the light source will go out and the cooling fans will run for a short time. The **POWER** indicator stops flashing green and changes to solid green when the projector enters Standby mode.
2. If you need to switch the projector off completely, wait until the projector enters Standby mode, then disconnect the AC power cable from the projector.

### Selecting an input signal

1. Connect one or more image sources to the projector.
2. Select the input you want to display:
  - Press one of the input buttons or the source button on the remote control.
  - Press **MENU** on the remote control or control panel and navigate to the Source setting in the Settings 1 tab, or press **SOURCE** on the control panel. Use the **UP** and **DOWN** navigation buttons to select the input source in the **SOURCE** menu. Press **ENTER** to confirm your choice.

### Selecting a test pattern

The following test patterns are available: RGB Ramps, Color Bars, Step Bars, Check Board, Grid, Horizontal Lines, Vertical Lines, Diagonal Lines, Horizontal Ramp, Vertical Ramp, White, Red, Green, Blue, Black, *None*.

To display a test pattern:

1. Press **MENU** on the remote or control panel to open the OSD.
2. Use the **LEFT** and **RIGHT** arrow buttons to access the **Settings 1** menu.
3. Use the **UP**, **DOWN** and **RETURN** buttons to access the **Advanced 2** sub menu.
4. Highlight **Test Pattern** and select a test pattern using the **LEFT** and **RIGHT** arrow buttons.

To return to the main image, set the test pattern to none and exit the OSD by pressing **EXIT**.

#### Notes

 The first time you use the projector, you can set OSD language from the quick menu. (See Setting the OSD language in the user manual.)

 See Connecting the power supply on page 17.

 The auto power on feature can be switched off in the Settings 2 menu. See Settings 2 Menu on page 58.

 Use only the power cable provided.

 Ensure that the power outlet includes a ground connection as this equipment **MUST** be earthed.

 Handle the power cable carefully and avoid sharp bends. Do not use a damaged power cable.

 See Using the menus on page 42 for full details of how to use the controls and the menu system.

## Adjusting the lens

The lens can be adjusted using the focus control on the lens:

- Use the focus control **1** on the lens to focus the image.

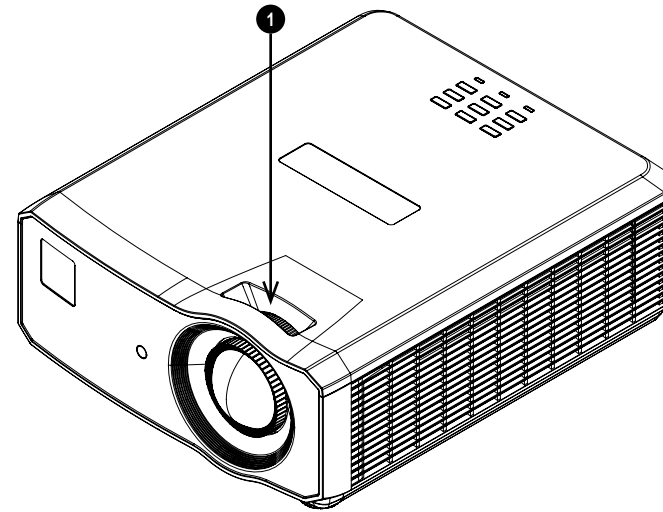

## Adjusting the image

### Orientation

This can be set from the **Settings 1** menu.

Highlight **Projection** and choose from **Desktop Front**, **Desktop Rear**, **Ceiling Front** and **Ceiling Rear**.

### Geometry

Settings such as **Keystone** and **4 Corners** can be set from the **Settings 1** menu.

### Picture

Settings such as **Display Modes**, **Brightness**, **Contrast**, **Color Manager** (Hue, **Saturation** and **Gain**), and **Advanced** (**Sharpness** and **Gamma**) can be set from the **Image** menu.

## Notes

 *Keystone requires an external signal input to enable it to be set.*

 *This product includes a DICOM simulation feature intended for training and other non-medical diagnosis purposes.*

## Adjusting the audio

The audio output can be adjusted using the remote control or OSD:

- Use the **Volume** button on the remote to open the volume bar. Use the LEFT and RIGHT arrow buttons to adjust the volume level.
- Use the **Mute** button on the remote to mute the audio.
- Press **MENU** on the remote or control panel to open the OSD. Navigate to the **Settings 1** menu and open the **Audio** sub menu to adjust the audio.

**Notes**

**This page is intentionally left blank**

**DIGITAL**   
 **PROJECTION**

A Delta Associate Company

# *E-Vision Laser 5100 Series*

High Brightness Digital Video Projector

CONNECTION GUIDE



## Signal inputs

### Digital inputs and outputs

1. **HDMI 1 / HDMI 2**  
HDMI 1.4a input. Connect an **HDMI** cable to the connector.
2. **HDMI 3 / MHL**  
HDMI 1.4a input. Connect an **HDMI** cable to the connector. Compatible with MHL devices. Connect a MHL cable to the projector.
3. **Service**  
This port is for servicing purposes only.
4. **USB**  
USB 5 V / 1.5 A output. Connect a USB cable to supply power to an external device.
5. **HDBaseT**  
Receives digital signal from HDBaseT-compliant devices. Connect an HDBaseT cable.

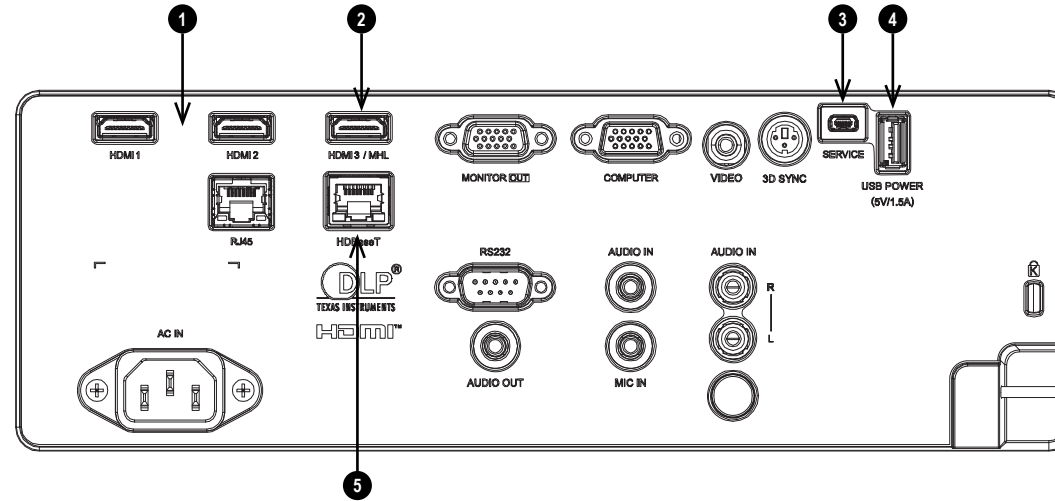

### Notes

*For simultaneous HDBaseT and LAN connectivity, a third-party distribution product can be utilised to combine HDBaseT video stream with LAN connection for delivery to the projector.*



## EDID on the HDMI, and HDBaseT inputs

If you are using a computer graphics card or another source that obeys the EDID protocol, the source will automatically configure itself to suit the capability of the projector.

Otherwise refer to the documentation supplied with the source to manually set the resolution to the DMD™ resolution of the projector or the nearest suitable setting. Switch off the source, connect to the projector, then switch the source back on again.

## Using HDMI / HDBaseT switchers with the projector

When using a DisplayPort/HDMI/HDBaseT source switcher with the projector, it is important to set the switcher so that it passes the projector EDID through to the source devices.

If this is not done, the projector may not be able to lock to the source or display the source correctly as its video output timings may not be compatible with those of the projector. Sometimes this is called transparent, pass-through or clone mode. See your switcher's manual for information on how to set this mode.

1. Sources
2. Switcher
3. Projector

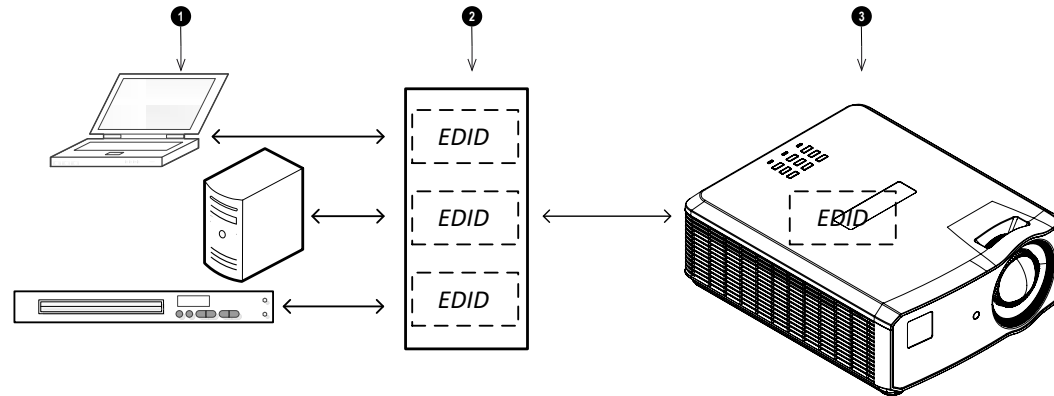

***The EDIDs in the switcher should be the same as the one in the projector.***

### Notes

**Analog inputs and outputs**

**1. Monitor Out**

Connect an analog monitor (VGA) cable to the 15-pin D-type to output the signal received on the Computer In input.

**2. Computer In**

This input receives analog signals from a computer. When using this input, it is best to use a fully wired VGA cable to connect the source to the projector. This will allow the source to determine the projector's capabilities via DDC and show an optimized image. Such cables can be identified as they have a blue connector shell.

**3. Video**

This input receives analog composite signals.

**4. Audio Out**

Use this Audio Out (3.5 mm stereo jack plug) to output audio.

**5. Audio In**

Use this Audio In (3.5 mm stereo jack plug) to input audio.

**6. Mic In**

Use this Mic In (3.5 mm stereo jack plug) to input a microphone.

**7. L & R Audio In (L+R RCA)**

Use this Audio In (L+R RCA) to input audio when the Composite Video input is selected.

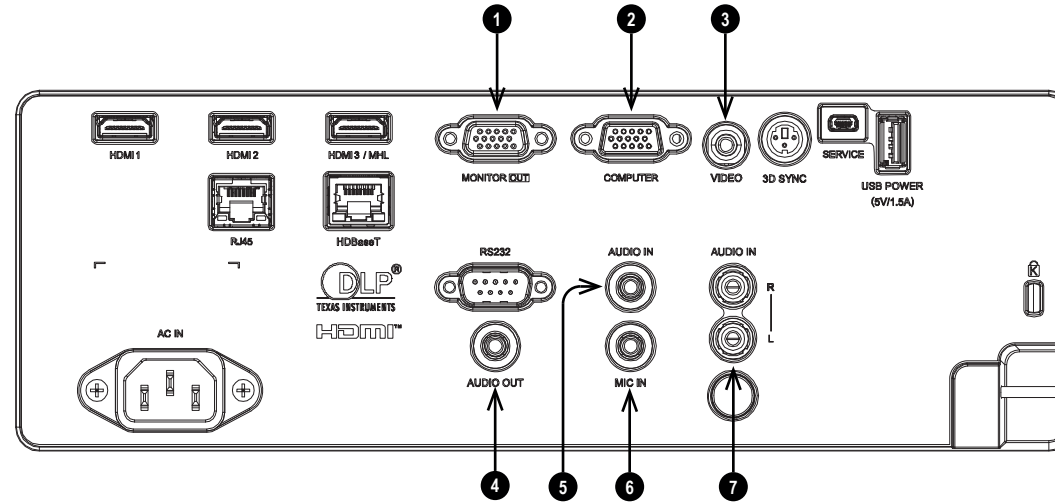

**Notes**

## 3D connections

1. **HDMI 1 / HDMI 2**  
HDMI 1.4a inputs supporting **Frame Sequential, Top and Bottom, Side By Side** and **Frame packing** 3D formats. See supported signal input modes on page 73. Connect an **HDMI** cable to the connector.
2. **3D Sync**  
Sync output signal. This is affected by settings in the 3D menu such as 3D Sync Out Delay and 3D Sync Output. Connect this to an IR emitter or ZScreen.
3. **HDBaseT**  
Receives 3D signal from HDBaseT-compliant devices. Connect an HDBaseT cable.

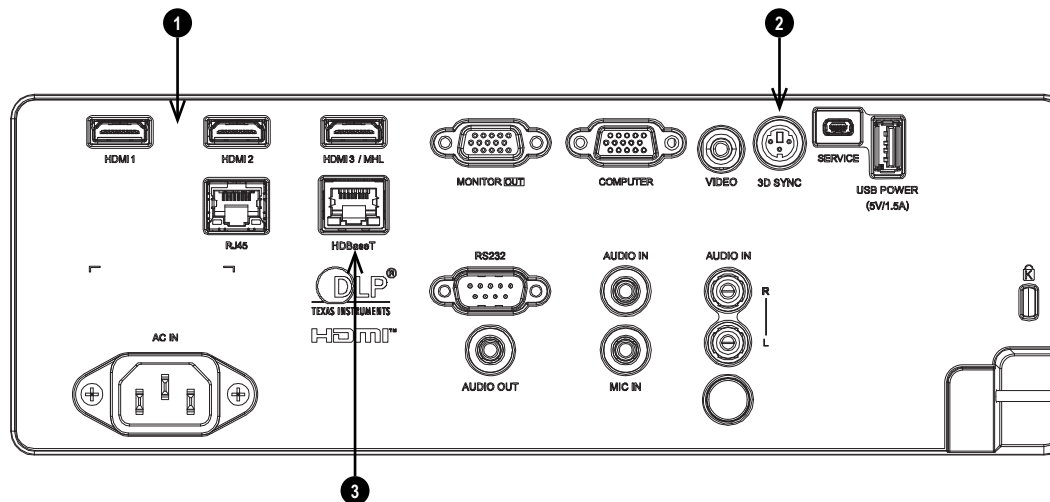

### Notes

### 3D Sync

1. 3D Sync In
2. IR emitter or Zscreen

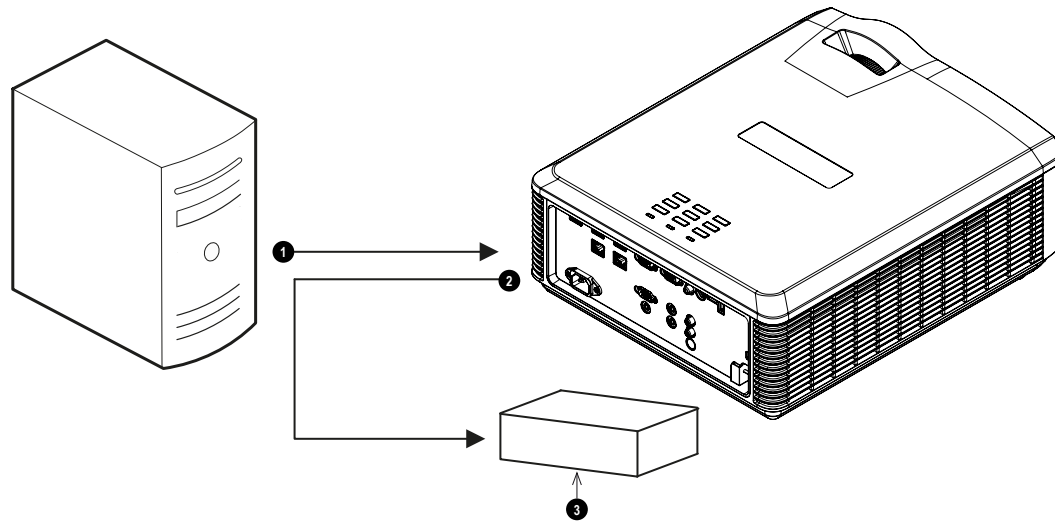



Notes

## Control connections

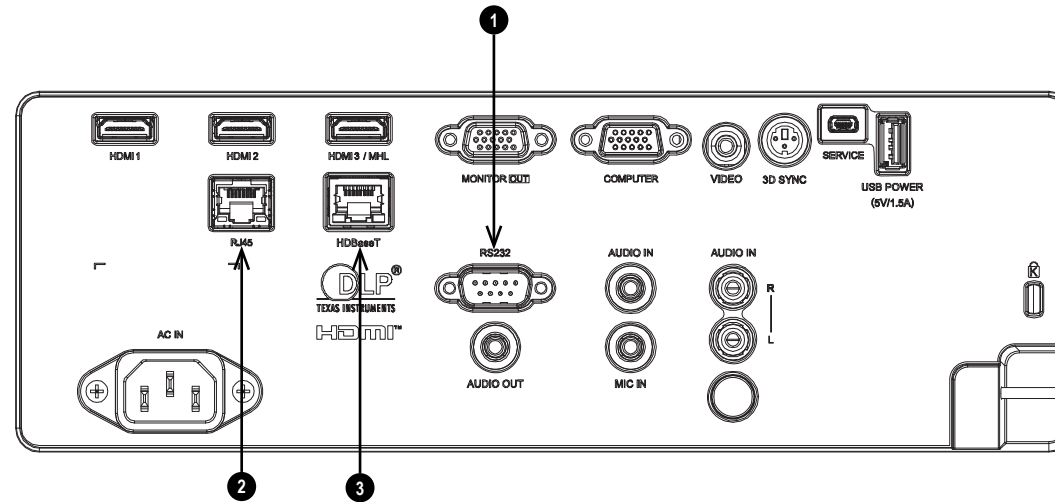
1. **RS232**  
All of the projector's features can be controlled via a serial connection, using commands described in the **Protocol Guide**. Use a straight-through cable to connect directly to a computer.
2. **RJ45**  
Dedicated LAN connection.
3. **HDBaseT**  
The projector's features can be controlled via a HDBase-T or LAN connection, using a terminal-emulation program.



### Notes

-  For a list of all commands used to control the projector via LAN, see the **Protocol Guide** (available separately).
-  Only one remote connection (RS232 or LAN) should be used at any one time.
-  With a LAN connection the projector can serve a web page offering status and projector controls.

### LAN connection examples

The projector's features can be controlled via a LAN connection, using Digital Projection's **Projector Controller** application or a terminal emulation program.

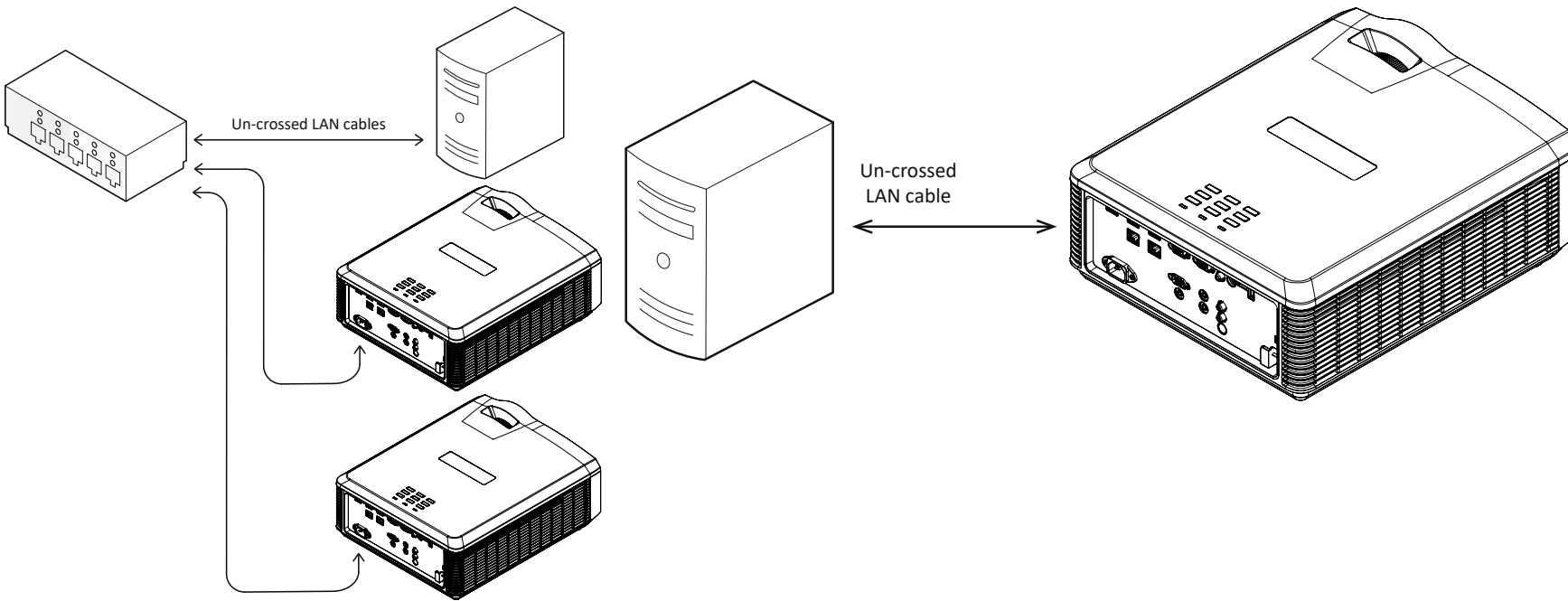

#### Notes

- ☞ With a LAN connection the projector can serve a web page offering basic projector controls.
- ☞ For simultaneous HDBaseT and LAN connectivity, a third-party distribution product can be utilised to combine HDBaseT video stream with LAN connection for delivery to the projector.

## RS232 connection example

All of the projector's features can be controlled via a serial connection, using commands described in the **Protocol Guide**.

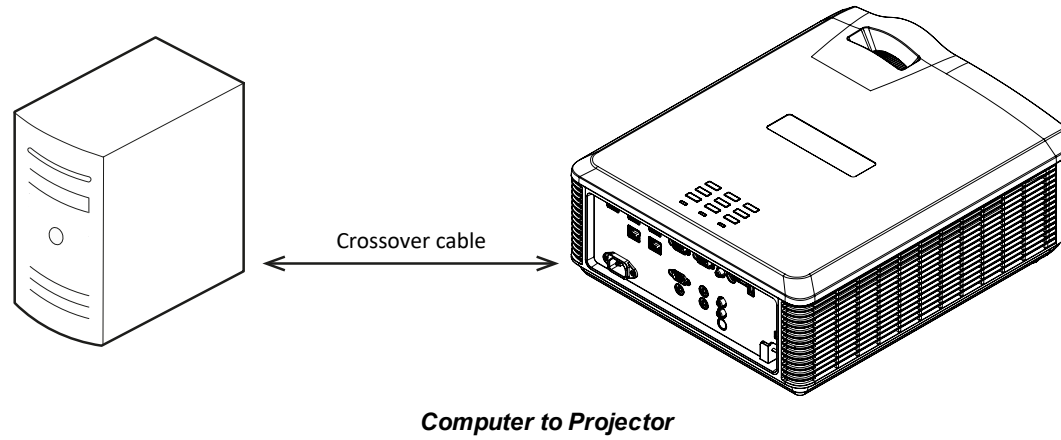

### Notes

 The **Protocol Guide** is available separately

**This page is intentionally left blank**



**DIGITAL**   
 **PROJECTION**

A Delta Associate Company

# *E-Vision Laser 5100 Series*

High Brightness Digital Video Projector

OPERATING GUIDE



## Using the menus

### Opening the Menu

Access the various menus using either the projector control panel or the remote control. On either device:

1. Press the **MENU** button. The on-screen display (OSD) opens showing the list of available menus

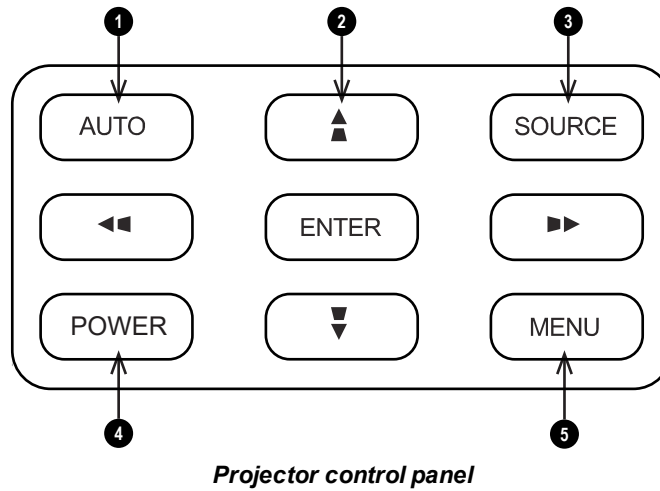

*Projector control panel*



*Remote control*

### Opening a submenu

Move up and down the list using the **UP** and **DOWN** arrow buttons.

To open a submenu:

1. Press **ENTER** on the control panel or remote control.

**Notes**

## Exiting menus and closing the OSD

To go back to the previous page:

1. Press **EXIT**.

To close the OSD:

1. Press **MENU**.

Or:

1. Go back to the top level menu
2. Press **EXIT**.

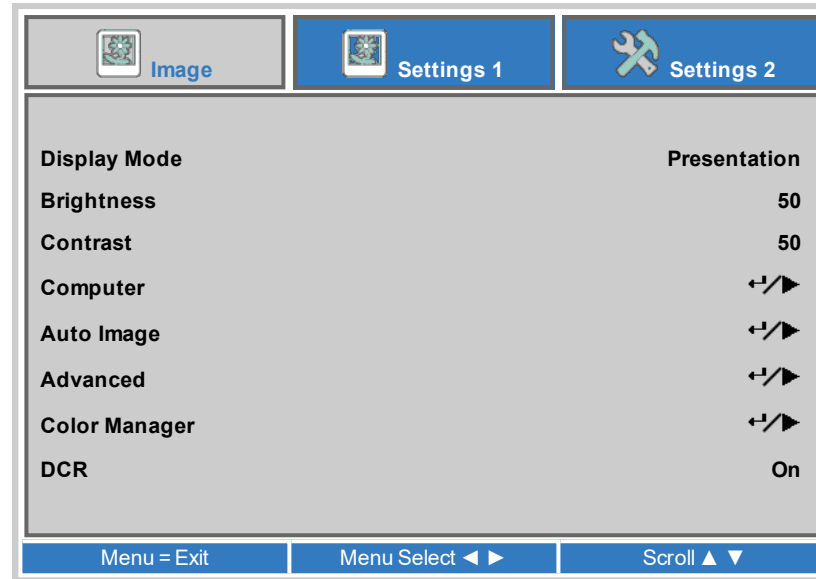

**Notes**

## Inside the Menu

When you open the OSD, a menu is displayed. There are three main menus:

- Image
- Settings 1
- Settings 2

Each menu is displayed at the top of the OSD. Available menus are highlighted in blue. The menu you are currently viewing is highlighted in gray.

The contents of each menu consists of the following elements:

- The path to the current menu. This is displayed when you are accessing a submenu.
- Highlighted item
- Available and unavailable items. Unavailable items appear a pale gray color. Whether an item is available may depend on other settings.
- The text or symbol to the right of an item shows whether the item:
  - has a value that can be changed (the current value is shown)
  - opens a sub-menu (a return/right arrow button is displayed)

The bottom of the OSD shows instructions for navigating the OSD. The instructions are highlighted in blue and change for each menu and submenu.

## Accessing sub menus

Use the **UP** and **DOWN** arrow buttons to highlight the sub-menu, then press **RETURN** or the **RIGHT ARROW** button.

Open Main Menu	Available Main Menu	Available Main Menu
Path (Main Menu ► Submenu)		
Item		Value
Highlighted Item		Value
Unavailable Item		
Item		Submenu ↵/▶
Item		Value Presentation
Item		Value 50
Instruction	Instruction	Instruction

## Notes

## Editing projector settings

If the highlighted menu item contains a list of values to choose from, you can change the value by doing the following:

1. Press the **UP** and **DOWN** arrow buttons to highlight the menu item.
2. Press the **LEFT** and **RIGHT** arrow buttons to change the value.

Menu	Menu	Menu
Item		Value
Highlighted Item		Value
Item		Value
Item		Value
Item		Value
Item		Value
Instruction	Instruction	Instruction

### Notes



Some menu items may be unavailable due to settings in other menus. Unavailable menu items appear gray.

## Executing commands

Some items are a command. Press **RETURN** or the **RIGHT ARROW** button.

You may be asked for confirmation. Use the **RETURN** or the **RIGHT ARROW** to confirm, or the **LEFT ARROW** to cancel.

## Using a slider to set a value

Some parameters show a slider. To set such a parameter:

1. Press the **LEFT** or **RIGHT** arrow button, or **RETURN**. The arrow buttons will open the slider and adjust the value at the same time. **RETURN** will open the slider without altering the initial value.
2. Use the **LEFT** and **RIGHT** arrow buttons to move the slider.
3. When ready, press **RETURN** to exit the slider and return to the menu.

Menu	Menu	Menu
Item		Value
Highlighted Item		Value
Item		Value
Item		Value
Item		Value
Item		Value
Instruction	Instruction	Instruction

## Editing numeric values

Some parameters take numeric values without using sliders - for example IP addresses.

1. Use the **UP** and **DOWN** arrow buttons to highlight the row containing the numeric field you wish to edit.
2. Press **RIGHT ARROW** button to enter edit mode. A numeric field in edit mode is white text on blue background
3. In edit mode:
  - Use the **UP** arrow button to increase the numeric value.
  - Use the **DOWN** arrow button to decrease the numeric value.
4. Use the **LEFT** and **RIGHT** arrow buttons to edit the next or previous numeric fields within the same row.
5. Once ready, press **RETURN** or the **LEFT ARROW** button to exit edit mode.

Menu	Menu	Menu
Item		255.255.255.255
Highlighted Item		255.255.255.255
Item		255.255.255.255
Item		255.255.255.255

Instruction      Instruction      Instruction

## Notes

## Using the projector

### Image Menu

- Display Mode  
Choose from **Presentation, Bright, Game, Movie, Vivid, TV, sRGB, DICOM SIM, User, and User 2.**  
Use a different setting depending the type of input source.
- Brightness, Contrast  
Use the slider to set the level as required.
- Computer  
Access the submenu to edit the settings.
- Auto Image  
Activate this option to automatically adjust the phase, tracking, size and position of the display.
- DCR  
Dynamic Contrast Ratio. Set to On to activate DCR. If the input signals level of black is  $\leq 5\%$  for four seconds then the laser power will dim to 0%. If the image level subsequently increases to  $>5\%$  for one second then the laser power will increase back to 100%.
- Advanced, Color Manager  
Access the submenu to edit the settings.

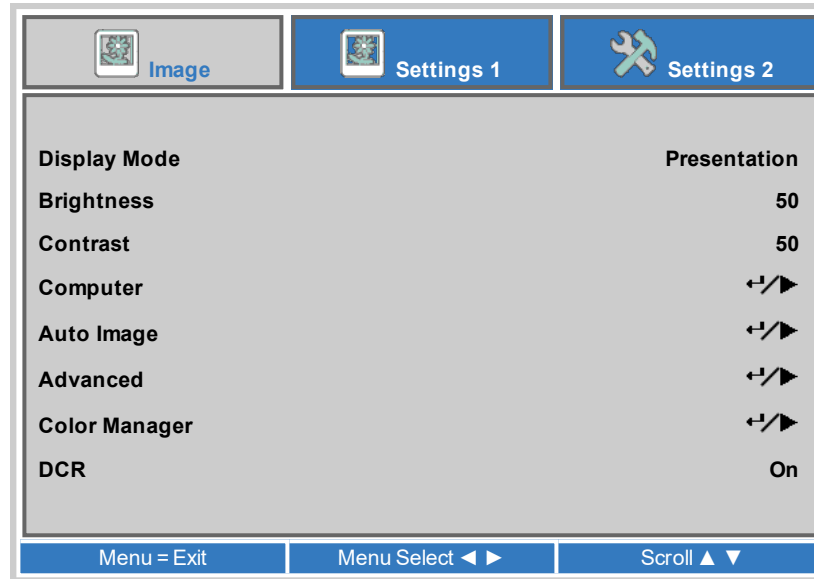

### Notes

 *DICOM is a simulation mode and should only be used for training and other non-medical diagnosis purposes.*

 *DCR is only available when the Light Mode is set to normal. See Settings 2 Menu on page 58*

## Computer

- **Horizontal Position, Vertical Position**  
Adjusts the horizontal and vertical display position. Use the slider to set the level as required.
- **Frequency**  
Adjusts the phase of the pixel sampling clock relative to the incoming signal. Adjust the phase if noise is visible. Use the slider to set the level as required.
- **Tracking**  
Adjusts the frequency of the pixel sampling clock. Flicker or vertical banding indicate poor tracking. Use the slider to set the level as required.
- **Auto Sync**  
Adjusts the horizontal and vertical position of the display based on the input source. Select from **On** or **Off**.

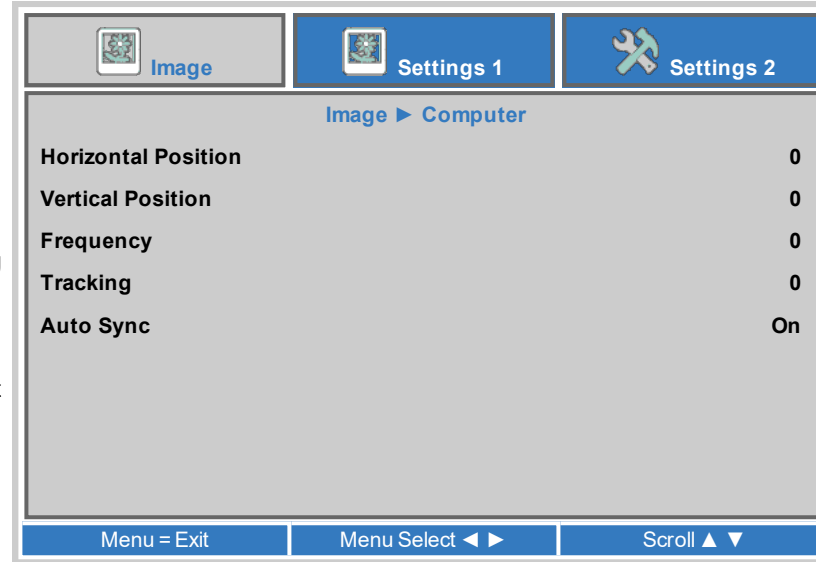

## Notes

*Some of the settings within the Position and Phase sub-menu, Frequency, Tracking and Auto Sync, affect only VGA input source. These settings are not available if the projector is using a different source.*



*Adjust the Frequency after adjusting Tracking.*

## Advanced

- **Brilliant Color, Sharpness**  
Use the slider to set the level as required.
- **Gamma**  
Choose a de-gamma curve from **1.8, 2.0, 2.2, 2.4, B&W, Linear**  
Used correctly, the **Gamma** setting can improve contrast while maintaining good details for blacks and whites. If excess ambient light washes out the image and it is difficult to see details in dark areas, lower the **Gamma** setting to compensate. This improves contrast while maintaining good details for blacks. Conversely, if the image is washed out and unnatural, with excessive detail in black areas, increase the setting.
- **Color Temperature**  
Choose from **Warm, Normal, Cold**
- **Video AGC**  
Select **ON** to activate the automatic gain control for the video source.
- **Video Saturation, Video Tint**  
Adjust the saturation and hue for the video source.
- **White Balance**  
Access the submenu to edit the settings.

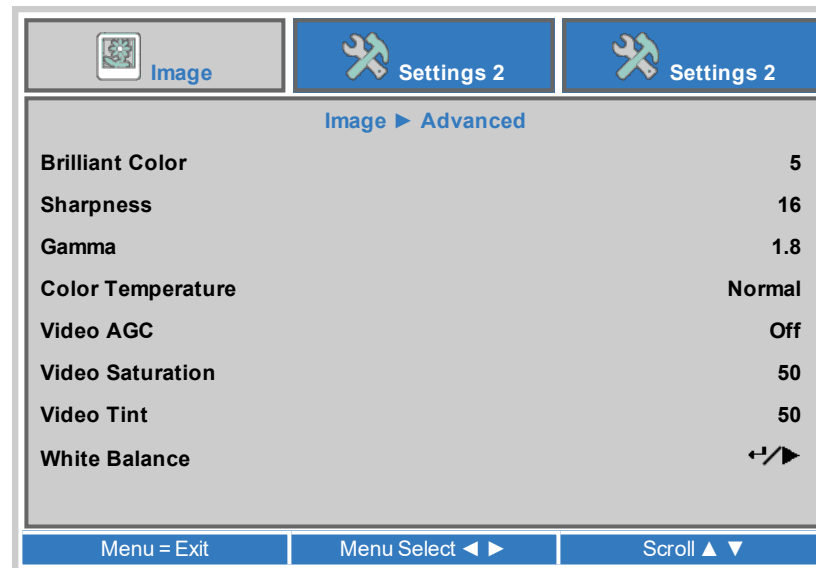



## White Balance

- R Gain, G Gain, B Gain  
Adjust the bright part of the scale for red, green and blue colors.
- R Offset, G Offset, B Offset  
Adjust the black levels for red, green and blue colors.

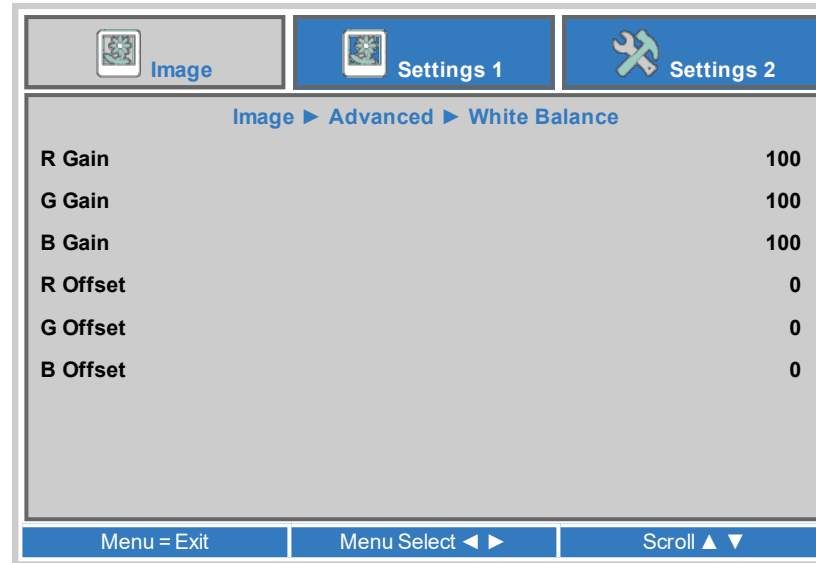

## Notes

## Color Manager

Access the submenu to edit the settings.

Adjust **Hue**, **Saturation** and **Gain** settings for each individual color to improve the color balance of the projected image.

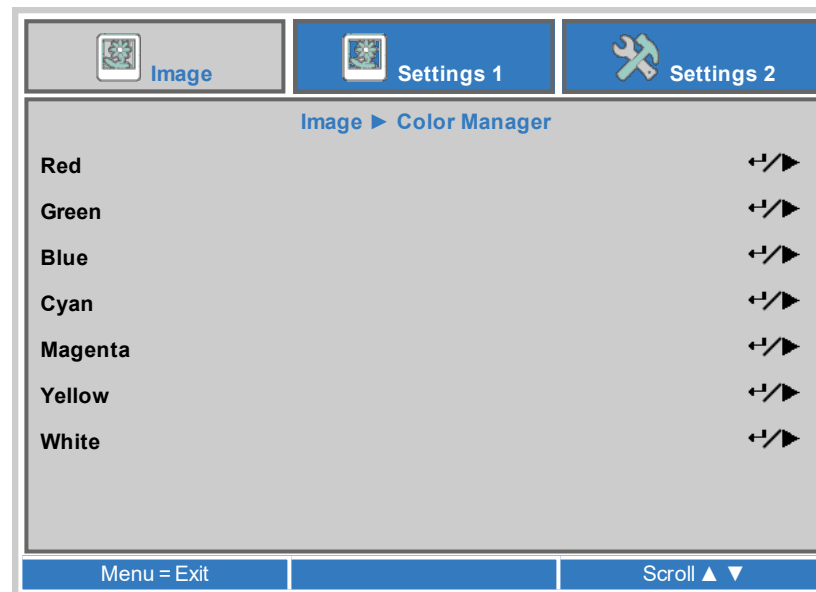

**Color manager parameters explained**

The levels of hue, saturation and gain in the Color Manager menu change the color values in the following ways:

1. **Hue** Specifies the position of each color (red, yellow, green, cyan, blue and magenta) relative to its neighboring colors.
2. **Saturation** Specifies the level of white in each color (i.e. how “pale” each color is).
3. **Gain** Controls the amount of light that goes into each color, i.e. the lowest gain would produce black.

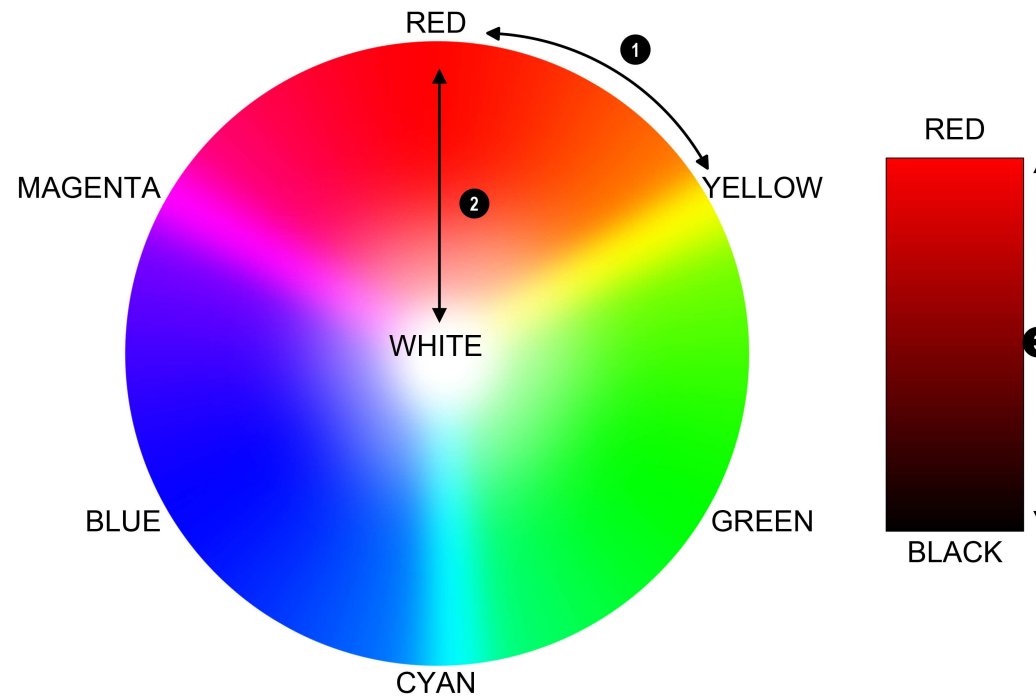
**Notes**

## Settings 1 Menu

- Source  
Access the submenu to edit the settings. Choose from **HDMI 1**, **HDMI 2**, **HDMI 3**, **MHL**, **VGA** (Computer In), **Composite Video** and **HDBaseT**.
- Projection  
Choose from **Desktop Front**, **Desktop Rear**, **Ceiling Front** and **Ceiling Rear**.
- Audio, Alignment  
Access the submenu to edit the settings.
- IR Setting  
Activate the IR remote control sensors on the projector. Choose from **All**, **Front IR** and **Rear IR**
- Advanced 1, Advanced 2  
Access the submenu to edit the settings.

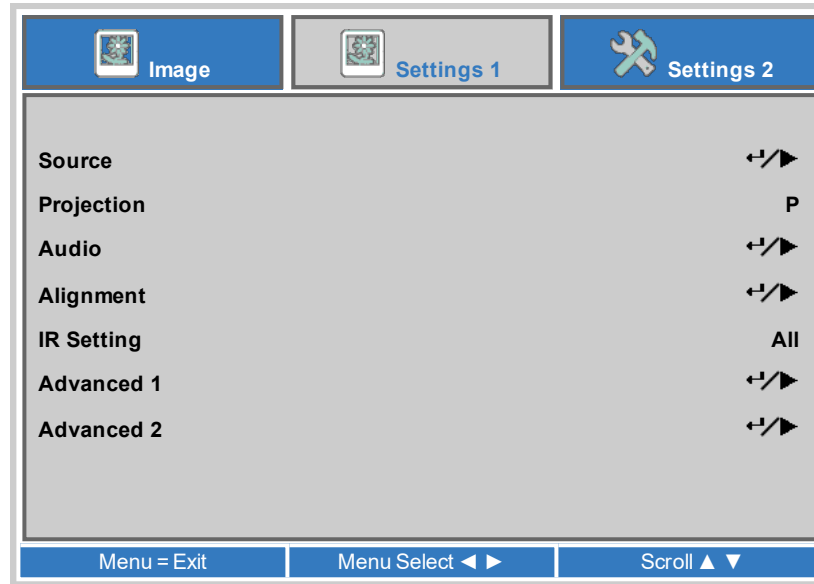

## Audio

- Volume  
Adjusts the volume output from the L&R audio outputs (L+R RCA). Use the slider to set the level as required.
- Mute  
Mutes the audio output from the L&R audio outputs (L+R RCA). Set to **On** or **Off**.
- MIC  
Turns a connected microphone **On** or **Off**.
- MIC Volume  
Adjusts the volume level of the microphone. Use the slider to set the level as required.

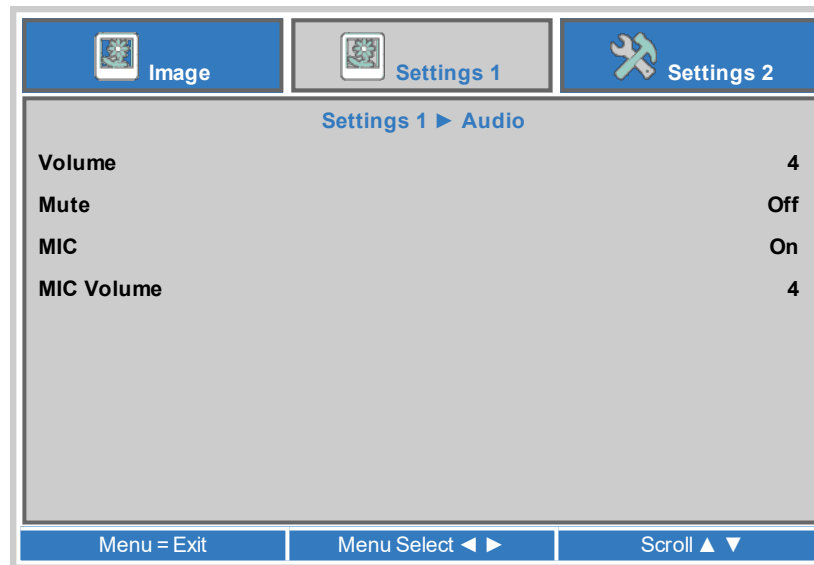

## Notes

### Alignment

- Aspect Ratio  
Set the aspect ratio for the projected image. Choose from **Fill**, **4:3**, **16:9**, **Letter Box**, **Native**, **2.35:1**.
- Digital Zoom  
Adjust to zoom into the center of the image. Use the slider to set the level as required.
- Keystone, 4 Corner  
Access the submenu to edit the settings.

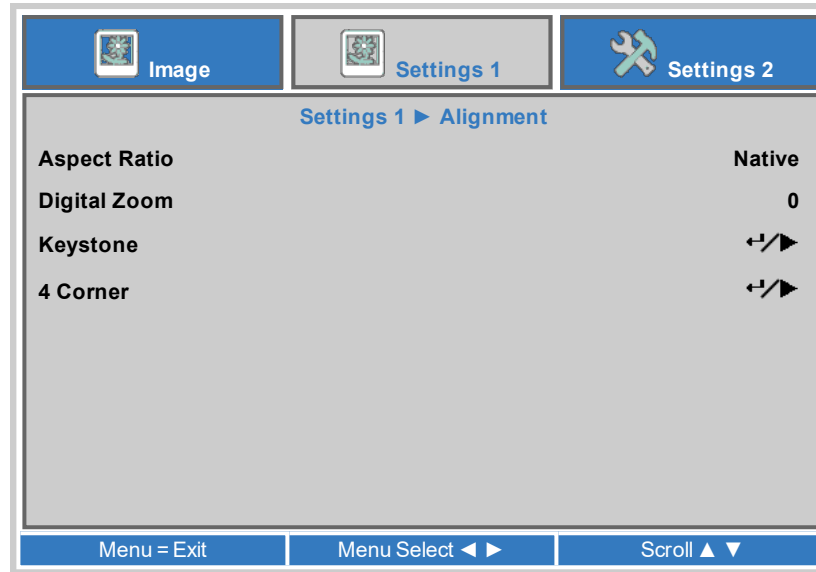

### Notes

### Keystone

Use this setting to compensate for any distortion caused by the projector being in a different horizontal or vertical plane to the screen.

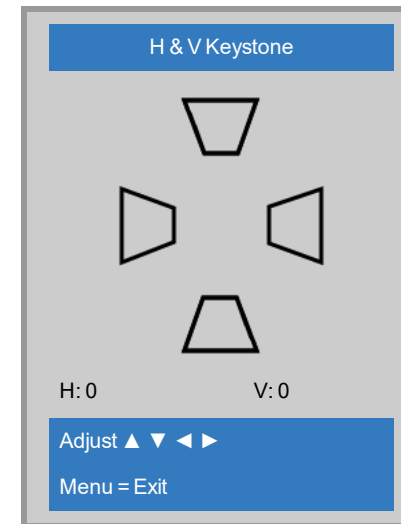

 *Keystone correction will reduce the resolution of the original image.*

**Keystone settings**

1. **Projector to the left** The projector is positioned to the left of the screen. To correct, apply a positive **Horizontal Keystone** value using the **RIGHT** arrow button.
2. **Projector to the right** The projector is positioned to the right of the screen. To correct, apply a negative **Horizontal Keystone** value using the **LEFT** arrow button.
3. **Projector high** The projector is positioned above the screen at a downward angle. To correct, apply a negative **Vertical Keystone** value using the **DOWN** arrow button.
4. **Projector low** The projector is positioned below the screen at an upward angle. To correct, apply a positive **Vertical Keystone** value using the **UP** arrow button.
5. **Projector straight** The projector is directly opposite the screen at a right angle both horizontally and vertically. No correction is needed.

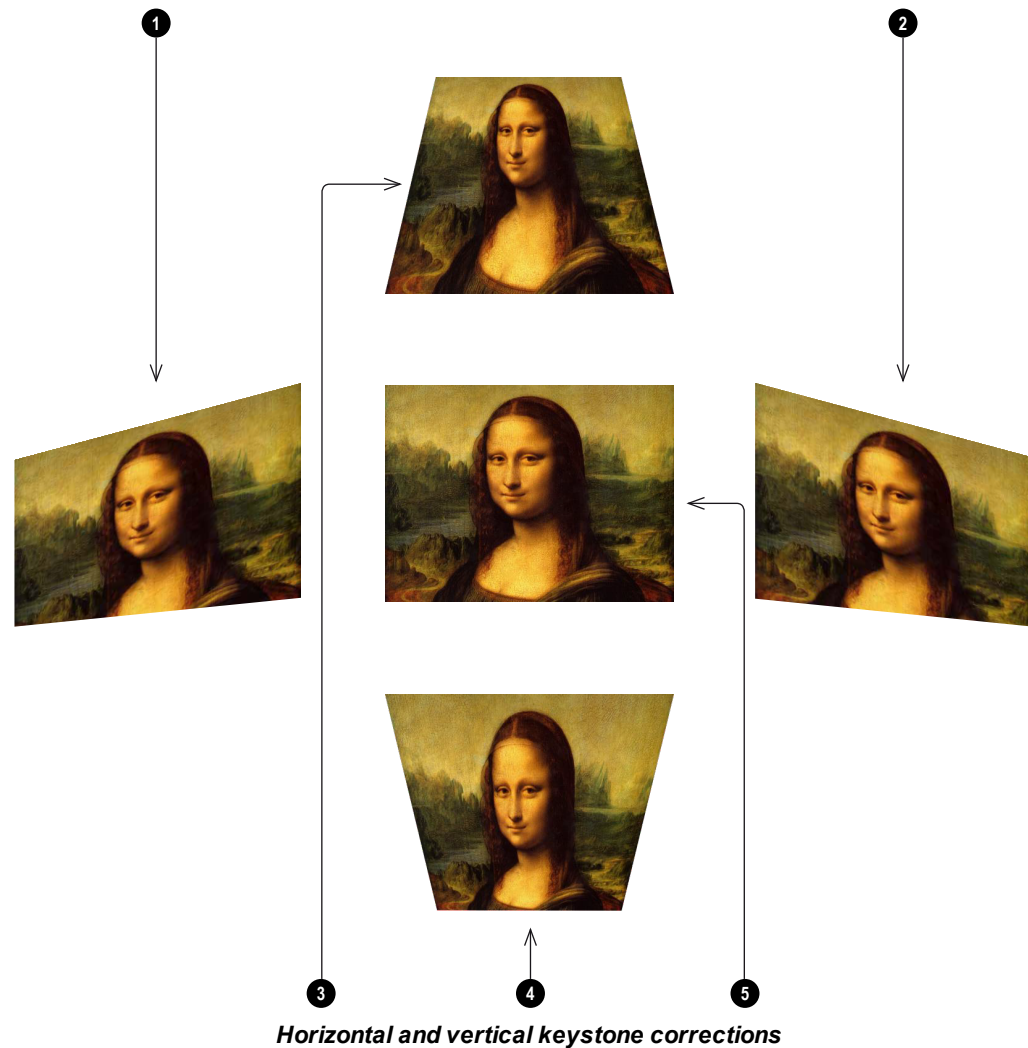
**Keystone example****Notes**

**The projector is positioned at an angle**

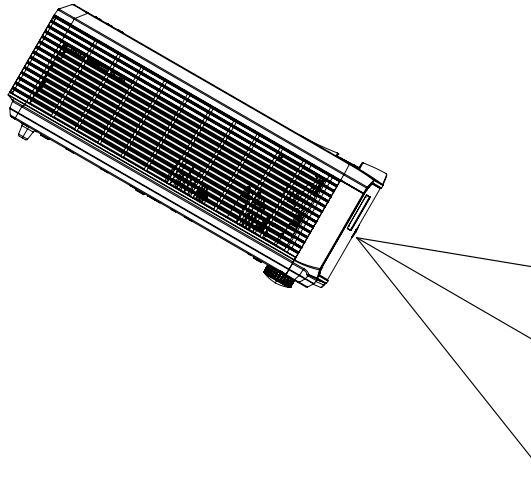

**The resulting image is distorted**



**The image is corrected when Keystone is applied**



**Notes**

**4 Corner**

For each corner, apply horizontal and / or vertical correction as necessary to restore the rectangular shape of the image.

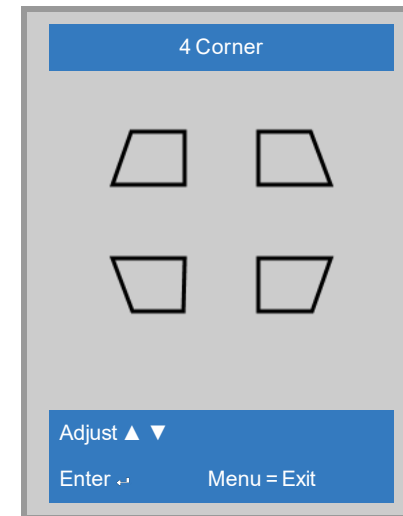

*Corner corrections provide a simple setup for awkward installations and irregular shaped screens that may distort the image. To apply a similar (but less flexible) correction, while preserving the original aspect ratio of the image, use the **Keystone** menu.*

**Advanced 1**

- Language  
Choose a language for the OSD from a choice of 27 available OSD languages.
- Security Lock  
Switches the security lock **On** or **Off**
- Blank Screen  
Select a color for the blank screen function operated by the remote. Choose from **Blank, Red, Green, Blue** or **White**.
- Splash Logo  
Select the splash logo to be displayed on startup. Choose from **Std, Black** or **Blue**.
- Closed Captioning  
Switches closed captioning **On** or **Off**.
- Keypad Lock  
Locks the keypad buttons on the remote. Press the ▼ key on the remote for 5 seconds to re-enable the keypad buttons.
- 3D Setting  
Access the submenu to edit the settings.

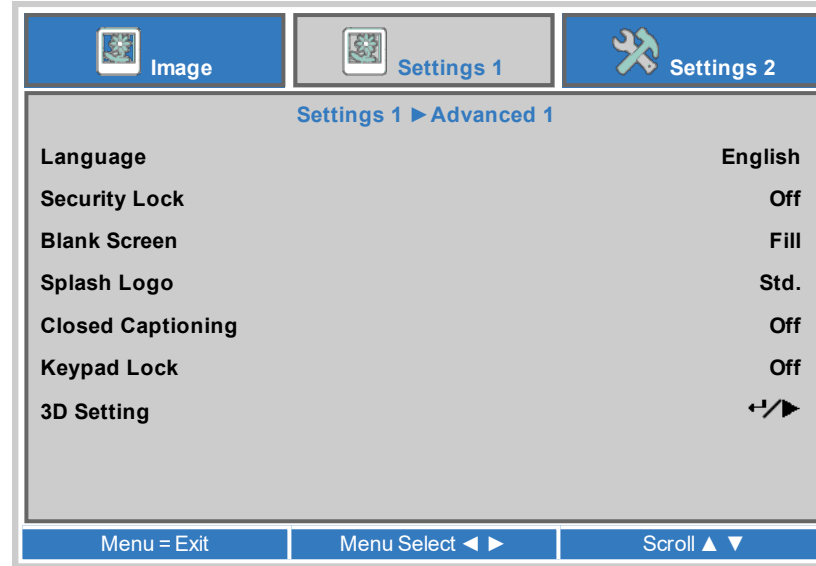

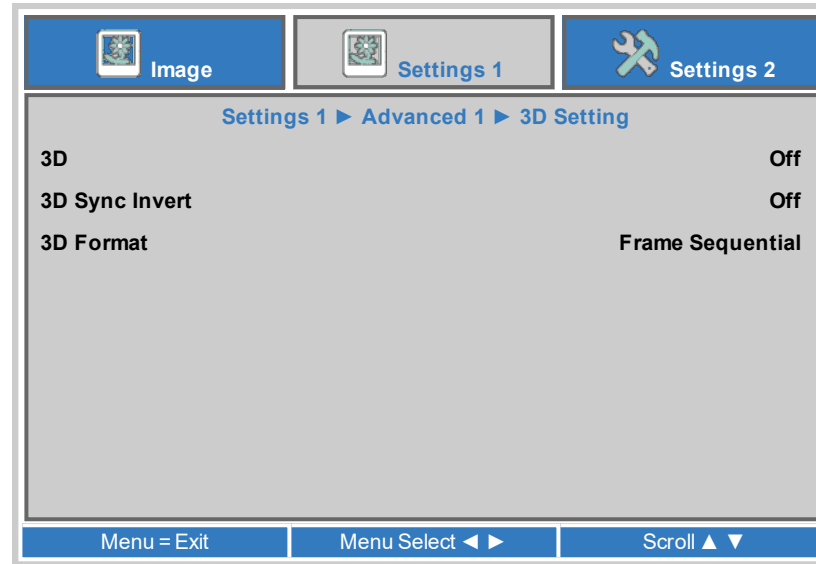

**Notes**

### 3D Setting

- 3D  
Choose **DLP-Link** when using 3D shutter glasses. Choose **IR** when using infrared 3D glasses.
- 3D Sync Invert  
Choose **On** to swap the left- and right-eye images, if they are displayed in the wrong order.
- 3D Format  
Choose the appropriate 3D format. Choose from **Frame Packing, Top and Bottom, Side-by-Side, Frame Sequential** and **Auto**.



### Notes

-  You must connect an Infrared emitter when using 3D IR (utilising Active 3D Glasses), alternatively a ZScreen system (utilising Passive Polarised 3D glasses) can be used.
-  If 3D is set to Off, all other 3D settings will be unavailable.
-  See 3D connections on page 35 for more information about supported 3D formats.
-  Also: See 3D types on the facing page
-  See 3D formats on page 75 for 3D resolutions and frame rates.



## 3D types

To display a 3D image it is first necessary to select the 3D format of the source. These formats are described below:

- **Frame Sequential** For sequential 3D, an external sync is required to identify left and right frames. If no sync is available from the sequential source, the projector will generate an output sync, but it may then be necessary to manually set the Eye Swap each time the player is started.
- **Frame Packing**
- **Side-By-Side**
- **Top/Bottom**

3D Sync Out Delay needs to be set only once, to optimize the image for the glasses in use.

## 3D Sync Invert

The outgoing 3D frames are in pairs - the dominant frame being presented first. You can determine which frame should be the dominant one.

By convention the default setting is **Left**.

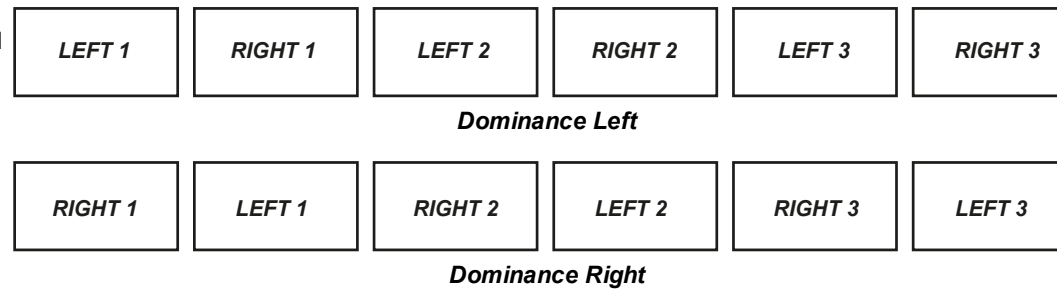

## Advanced 2

- **Test Pattern**  
Select a test pattern to display. Choose from: RGB Ramps, Color Bars, Step Bars, Check Board, Grid, Horizontal Lines, Vertical Lines, Diagonal Lines, Horizontal Ramp, Vertical Ramp, White, Red, Green, Blue, Black, *None*.
- **H Image Shift**  
Use the slider to set the level as required.
- **V Image Shift**  
Use the slider to set the level as required.

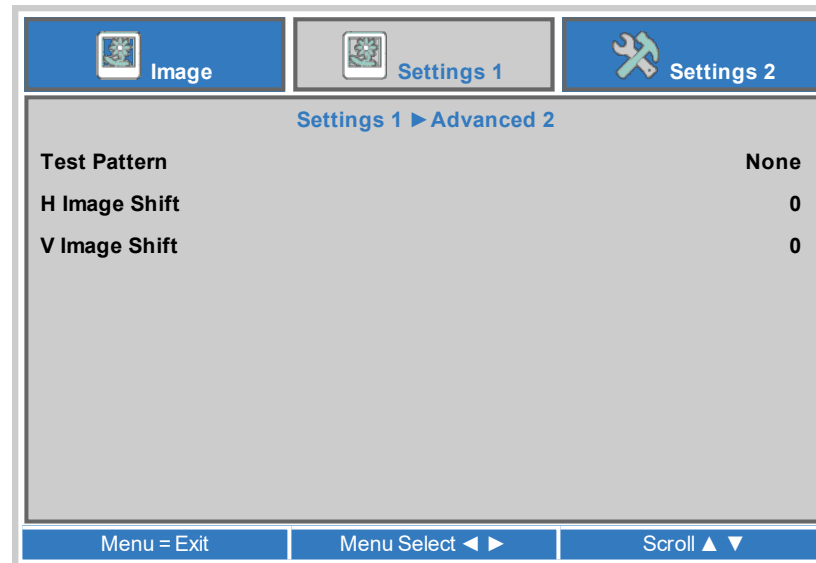

**Notes**

## Settings 2 Menu

- **Auto Source**  
If this setting is **On**, the projector will automatically search for an active input source.
- **No Signal Power Off (min)**  
Set a duration to wait (0 to 180 mins) before switching the light source off when there is no input signal.
- **Auto Power On**  
Set to **On** to automatically power the projector on when the power cable is inserted. When set to **Off**, use the power button on the control panel or the on and off buttons on the remote to switch the projector on or off.
- **Light Mode**
  - **Normal** will set the laser power to 100%.
  - **Eco** will reduce the laser power to 80%.
  - **Dimming** will reduce the laser power to 40%
  - **Extreme Dimming** will reduce the laser power to 25%.
  - **Custom Light** will activate the custom light and constant brightness settings.
  - **Constant Brightness** will maintain the projectors set brightness until the maximum laser power has been reached (this maximum laser power will decrease overtime). Hence, the lower the set Constant Brightness power level the longer the set brightness output will be maintained.
- **Reset All**  
Press  to reset all settings to the factory defaults.
- **Status. Advanced 1, Advanced 2**  
Access the submenu to edit the settings.
- **Custom Light**  
This setting is only available if **Light Mode** is set to **Custom Light**.  
Choose a value between 25% to 100% laser power.

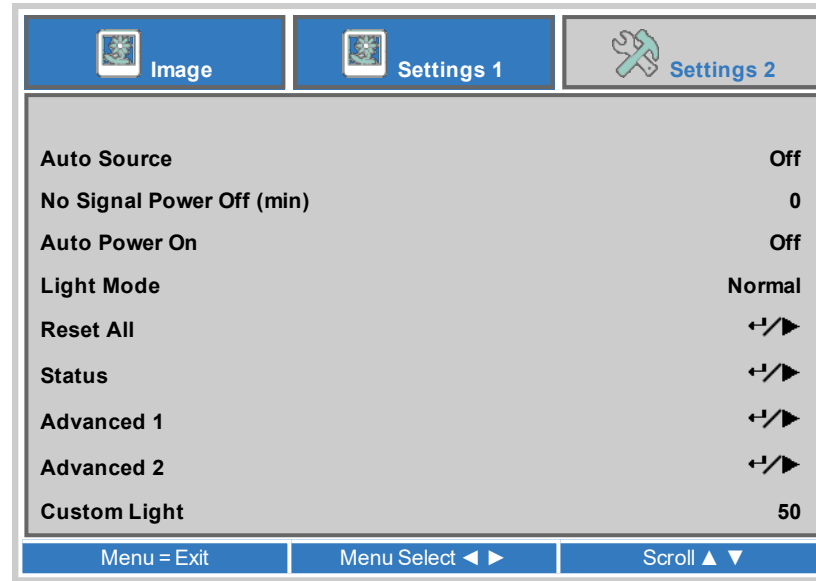

Notes

## Status

This menu gives information about software and hardware configuration, input source and laser operating times.

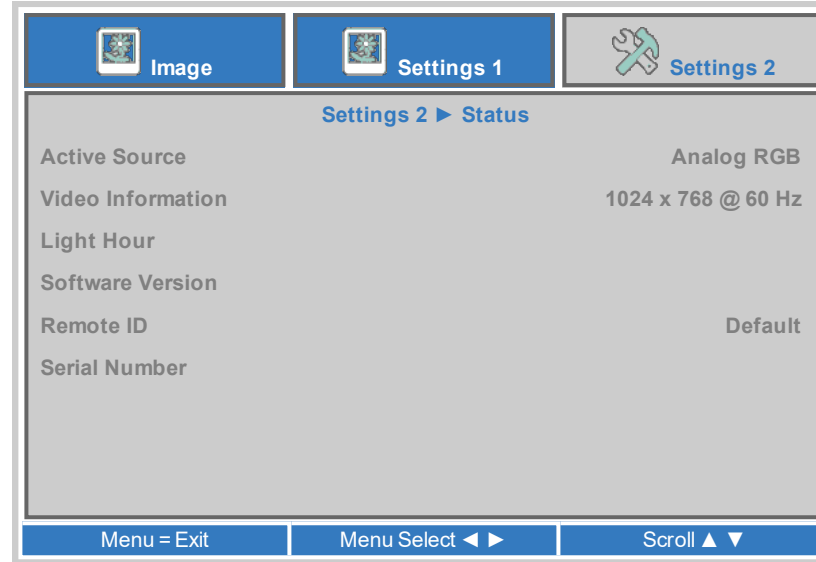

## Notes

## Network

- Network State  
Displays the current network status.
- DHCP, IP Address, Subnet Mask, Gateway, DNS  
Set **DHCP** to **On** if the IP address is to be assigned by a DHCP server, or **Off** if it is to be set here.  
If **DHCP** is **On**, it will not be possible to edit **IP Address**, **Subnet Mask**, **Gateway** or **DNS**.  
If **DHCP** is set to **Off**, edit **IP Address**, **Subnet Mask**, **Gateway** and **DNS** as required.
- Apply  
Select to apply any changes to the network setup.

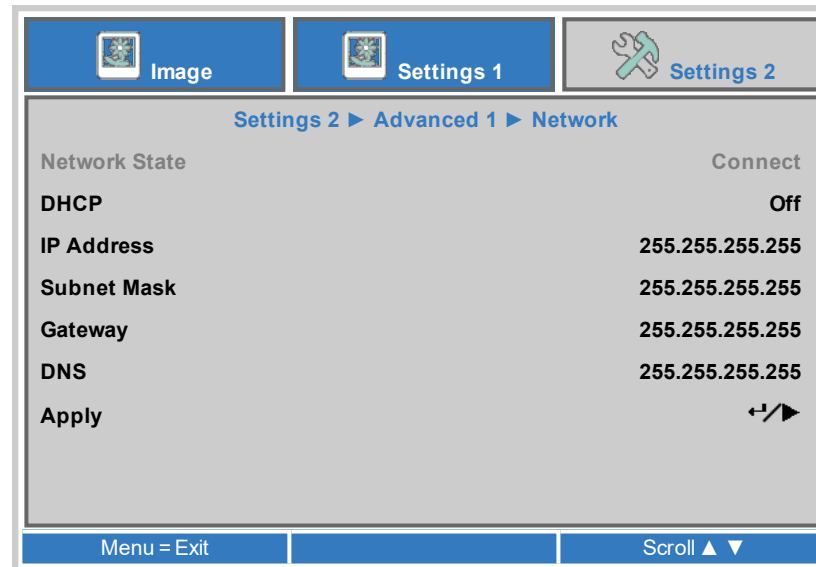

**Advanced 2**

- **Sleep Timer (min)**  
Turns the projector off after a period of time. Set the number of minutes for the timer.
- **Source Filter**  
Allows you to enable or disable individual input source connections. Access the submenu to edit the settings.

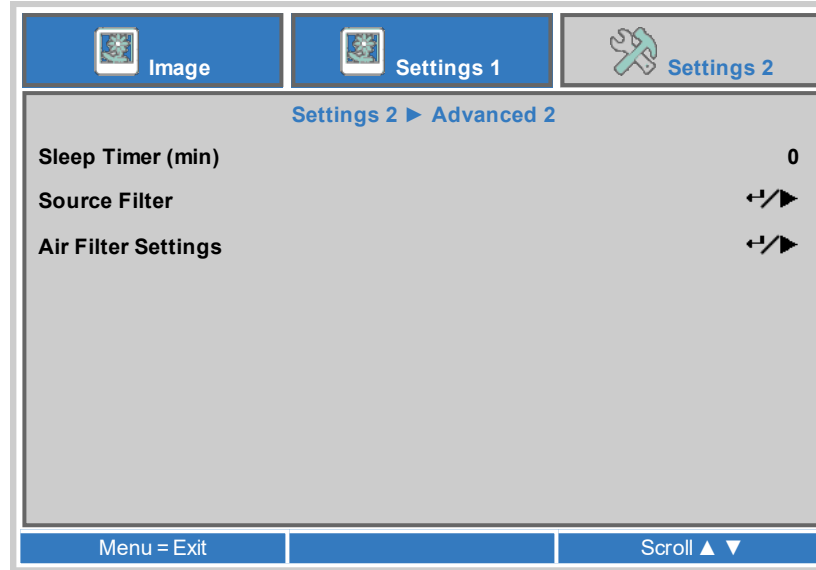

**Air Filter Settings**

This projector does not require air filters. The optical engine is sealed. Please leave the Air Filter Settings as the factory default.

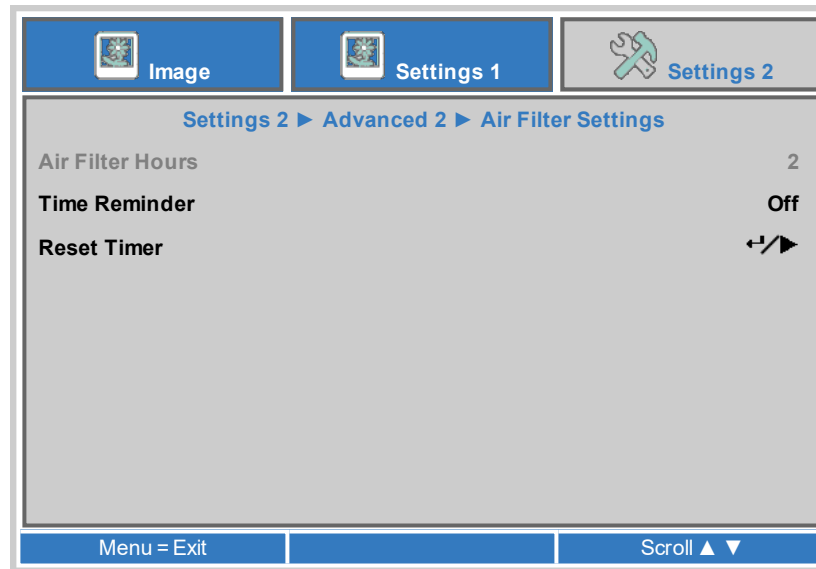

**Notes**

## Served web pages

The served web pages allow you to control the projector remotely via LAN.

The default IP address is **10.10.10.10**.

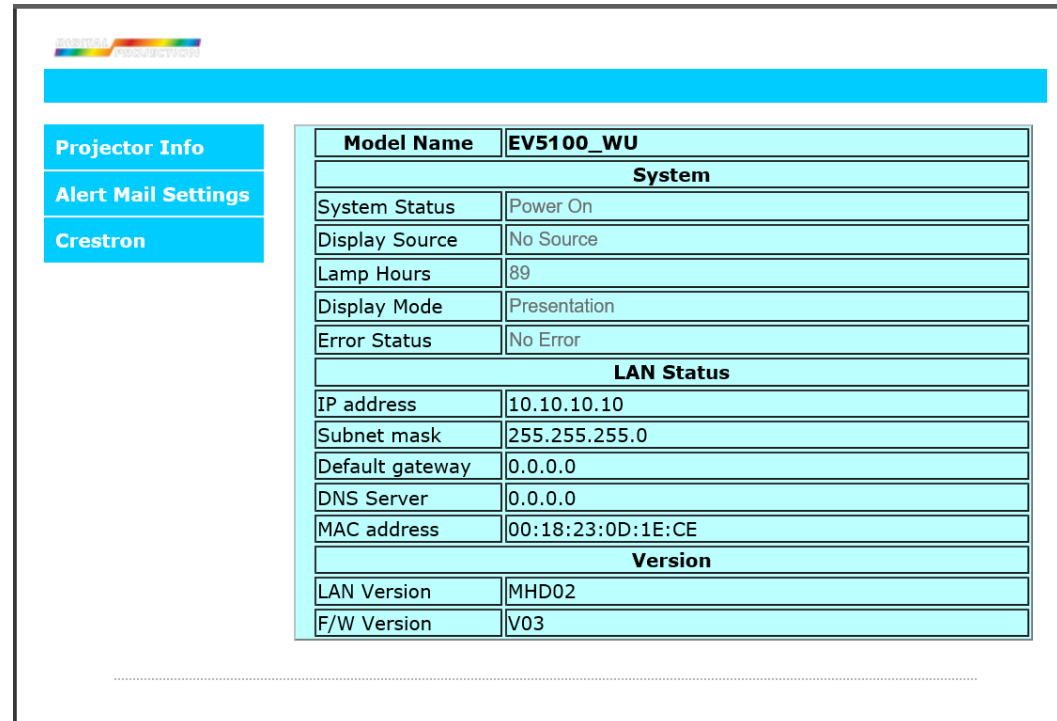

The screenshot displays the projector's web interface. On the left, there is a navigation menu with three items: "Projector Info", "Alert Mail Settings", and "Crestron". The main content area shows a table of system and LAN status information.

Model Name		EV5100_WU
<b>System</b>		
System Status	Power On	
Display Source	No Source	
Lamp Hours	89	
Display Mode	Presentation	
Error Status	No Error	
<b>LAN Status</b>		
IP address	10.10.10.10	
Subnet mask	255.255.255.0	
Default gateway	0.0.0.0	
DNS Server	0.0.0.0	
MAC address	00:18:23:0D:1E:CE	
<b>Version</b>		
LAN Version	MHD02	
F/W Version	V03	

**Notes**

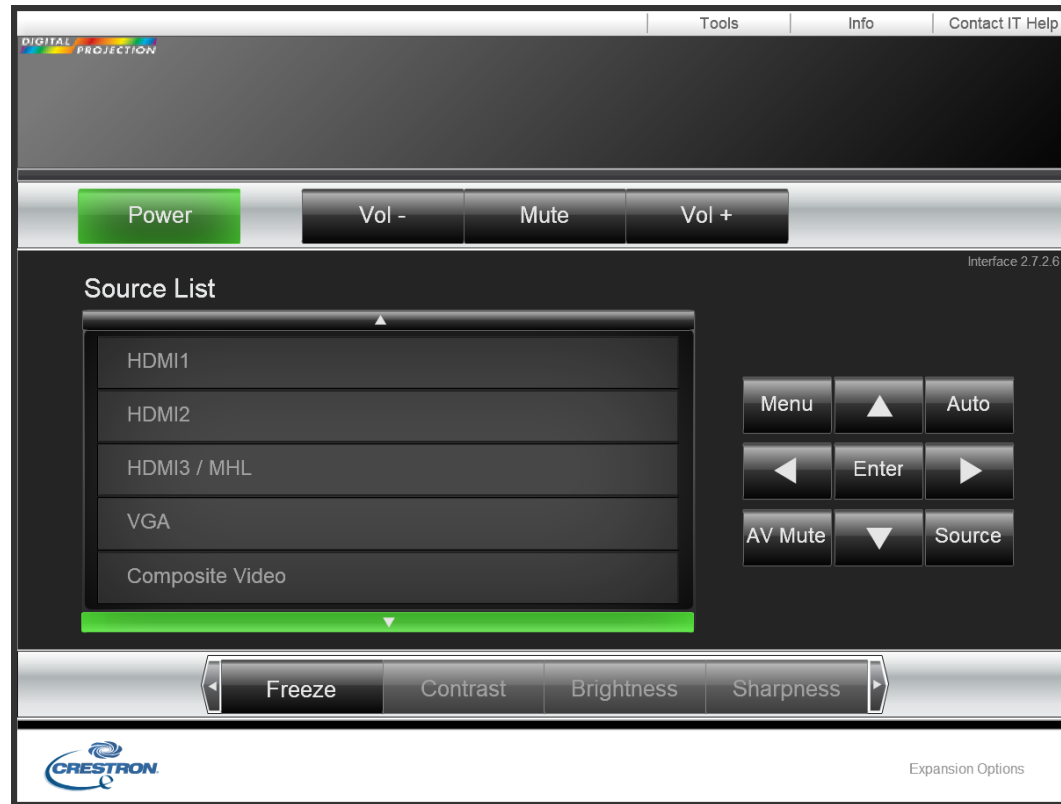

**Notes**

DIGITAL PROJECTION

Tools | Info | Contact IT Help

---

<b>Crestron Control</b> IP Address <input type="text" value="192.168.0.2"/> IP ID <input type="text" value="5"/> Control Port <input type="text" value="41794"/> <input type="button" value="Send"/>	<b>Projector</b> Projector Name <input type="text"/> Location <input type="text" value="7A"/> Assigned To <input type="text" value="TT"/> <input type="button" value="Send"/> DHCP <input type="checkbox"/> DHCP Enabled IP Address <input type="text" value="10.10.10.10"/> Subnet Mask <input type="text" value="255.255.255.0"/> Default Gateway <input type="text" value="0.0.0.0"/> DNS Server <input type="text" value="0.0.0.0"/> <input type="button" value="Send"/>	<b>User Password</b> <input type="checkbox"/> Enabled New Password <input type="text"/> Confirm <input type="text"/> <input type="button" value="Send"/> <b>Admin Password</b> <input type="checkbox"/> Enabled New Password <input type="text"/> Confirm <input type="text"/> <input type="button" value="Send"/>
--	--	---

 Expansion Options

**Notes**

**Projector Info**

**Alert Mail Settings**

**Crestron**

## Send E-Mail

Enter the appropriate settings in the fields below:  
(Your SMTP server may not require a user name or password.)

**SMTP Server:**  **Port:**

**User Name:**

**Password:**

**From:**

**To:**

**CC:**

**E-mail Alert Options:**

<b>Fan lock :</b>	<input checked="" type="checkbox"/>	<b>Over_Heat:</b>	<input checked="" type="checkbox"/>
<b>Case Open:</b>	<input checked="" type="checkbox"/>	<b>Lamp Fail:</b>	<input checked="" type="checkbox"/>
<b>Lamp Hours Over:</b>	<input checked="" type="checkbox"/>	<b>Filter Hours Over:</b>	<input checked="" type="checkbox"/>
<b>Other Error:</b>	<input checked="" type="checkbox"/>	<b>Weekly Report:</b>	<input type="checkbox"/>



**DIGITAL**   
 **PROJECTION**

A Delta Associate Company

# *E-Vision Laser 5100 Series*

High Brightness Digital Video Projector

REFERENCE GUIDE



**Screen requirements**

Notes

**Fitting the image to the display**

If the source image supplied to the projector is smaller than the WUXGA resolution, the image will not fill the display. The following examples show how a number of common formats may be displayed, depending on your DMD™ resolution.

**WUXGA images displayed full width**

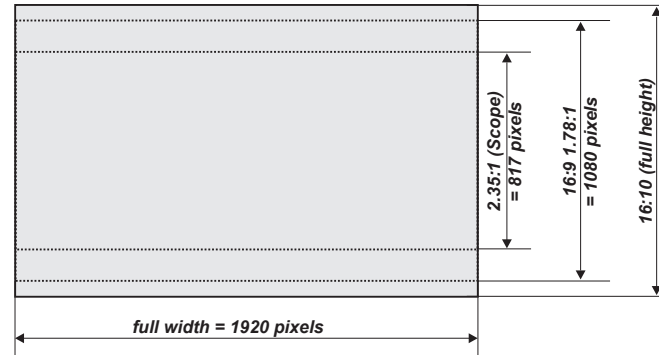

**WUXGA images displayed with a height of 1200 pixels**

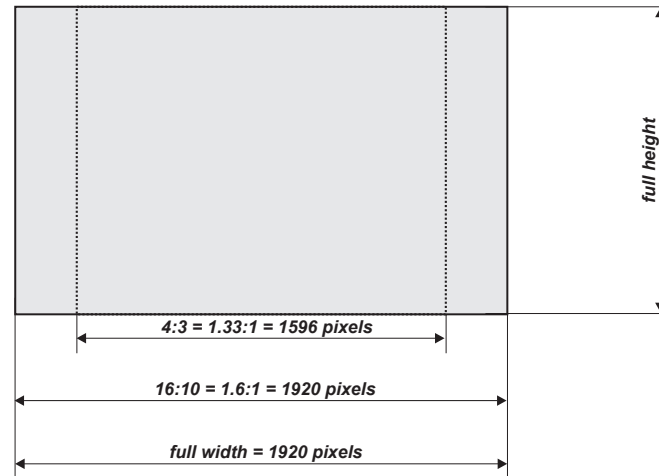

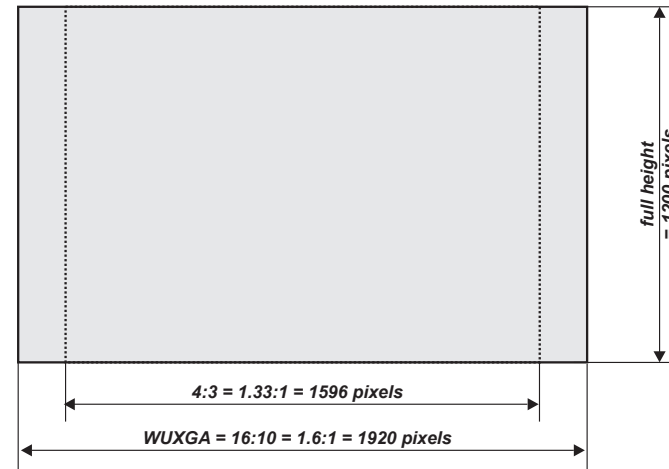
**WUXGA images displayed full height****Notes****Diagonal screen sizes**

Screen sizes are sometimes specified by their diagonal size (D). When dealing with large screens and projection distances at different aspect ratios, it is more convenient to measure screen width (W) and height (H).

The example calculations below show how to convert diagonal sizes into width and height, at various aspect ratios.

**2.35:1 (Scope)**

$$W = D \times 0.92 \quad H = D \times 0.39$$

**1.85:1**

$$W = D \times 0.88 \quad H = D \times 0.47$$

**16:9 = 1.78:1**

$$W = D \times 0.87 \quad H = D \times 0.49$$

**16:10 = 1.6:1 (native aspect ratio for WUXGA projectors)**

$$W = D \times 0.85 \quad H = D \times 0.53$$

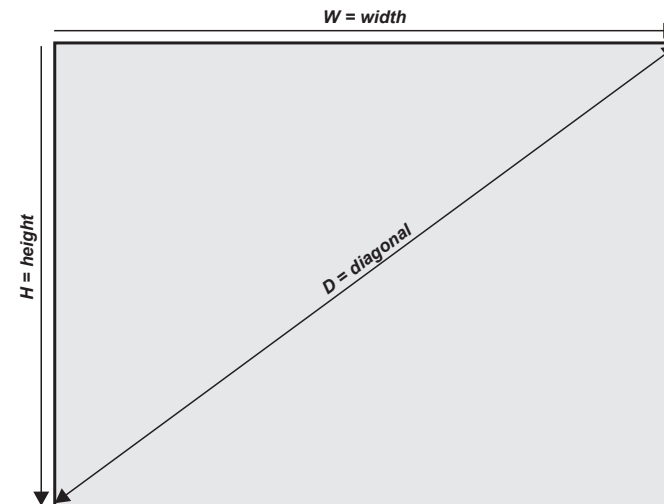

## Aspect ratios explained

The appearance of a projected image on the screen depends on a combination of the following:

- The display resolution is **WUXGA** with a 1920 x 1200 resolution, corresponding to an aspect ratio of 16:10
- The aspect ratio of the input signal: usually **4:3**, **16:9** or **16:10**
- The value of the **Aspect Ratio** setting of the projector:
  - **16:9**, **4:3**, **16:10** and **5:4** stretch the image to the selected aspect ratio. **16:9** leaves black bars at the top and bottom of the screen (letterboxing effect); **4:3** and **5:4** leave black bars at the sides of the screen (pillarboxing).
  - **TheaterScope** is a special setting used in combination with an anamorphic lens, an optional accessory. It removes letterboxing from a 2.35:1 source packed into a 16:9 frame.
  - **Source** shows the image with its original aspect ratio, if this does not match the native aspect ratio of the DMD™, then the image will be scaled to either fit the full width or height of the display.

### Aspect ratios examples

1. Unused screen areas

**Source: 4:3**

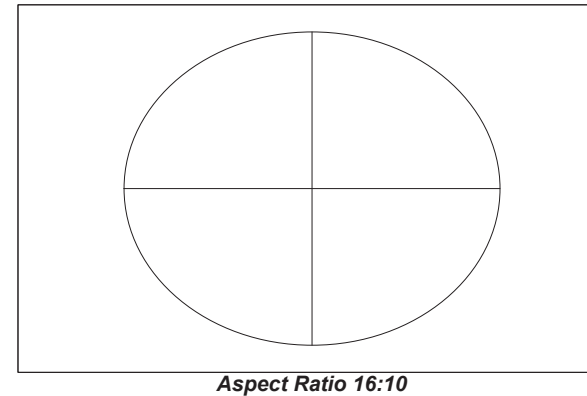
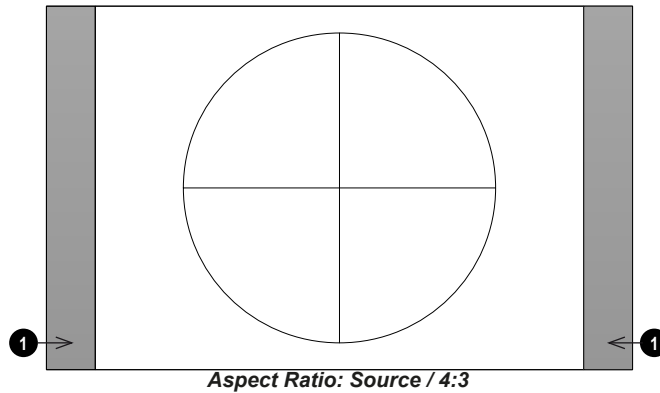

**Notes**

Source: 16:9

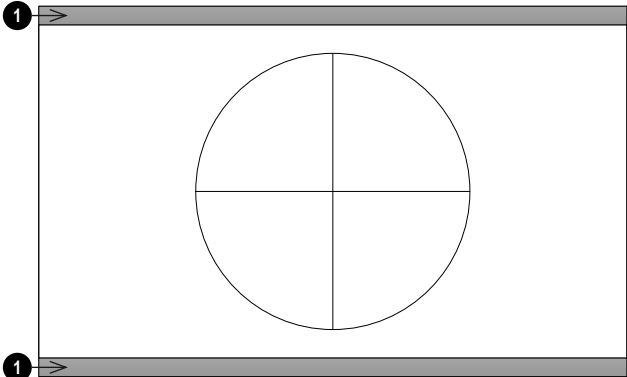

Aspect Ratio: Source / 16:9

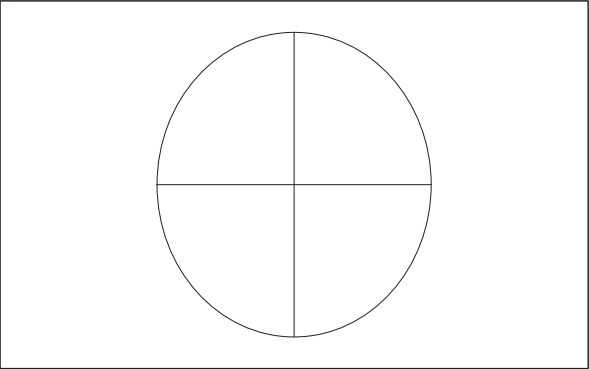

Aspect Ratio 16:10

Source: 16:10 (native)

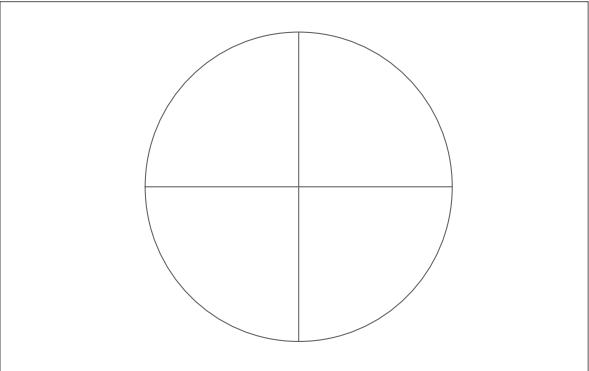

Aspect Ratio: Source / 16:10

Notes

**Aspect ratio example: TheatreScope**

The TheaterScope setting is used in combination with an anamorphic lens to restore 2.35:1 images packed into a 16:9 frame. Such images are projected with black lines at the top and bottom of the 16:9 screen to make up for the difference in aspect ratios.

Without an anamorphic lens and without the TheaterScope setting applied, a 16:9 source containing a 2.35:1 image looks like this:

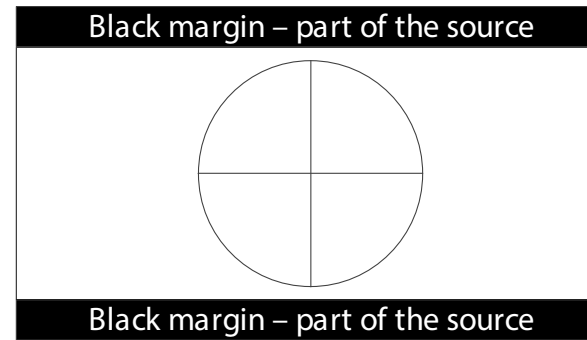

If we change the setting to TheaterScope, the black lines will disappear but the image will stretch vertically to reach the top and bottom of the DMD™:

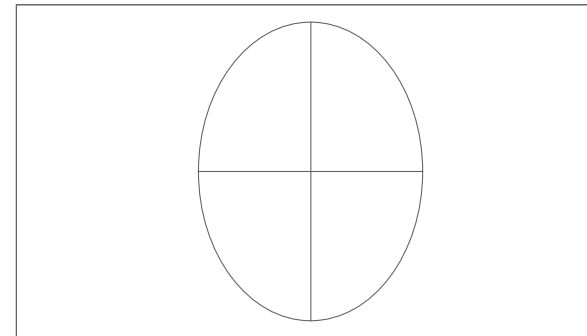

An anamorphic lens will stretch the image horizontally, restoring the original 2.35 ratio:

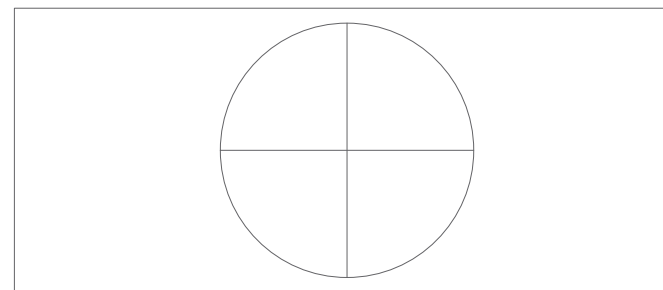

**Notes**

## Appendix A: projector indicator messages

Power LED	Light LED	Temperature LED	Message
On Continuously	Off	Off	Light Source Ready
Flashing Continuously	Off	Off	Starting up or cooling down
Off	1 Flash	On Continuously	Over Temperature T1
Off	2 Flashes	On Continuously	Over Temperature T2
Off	3 Flashes	On Continuously	Over Temperature T3
Off	4 Flashes	On Continuously	Over Temperature T4
Off	5 Flashes	On Continuously	Over Temperature T5
4 Flashes	Off	Off	Thermal Break Sensor error
5 Flashes	Off	Off	Light Source error
6 Flashes	1 Flash	Off	FAN1 error
6 Flashes	2 Flashes	Off	FAN2 error
6 Flashes	3 Flashes	Off	FAN3 error
6 Flashes	4 Flashes	Off	FAN4 error
6 Flashes	5 Flashes	Off	FAN5 error
6 Flashes	6 Flashes	Off	FAN6 error
6 Flashes	7 Flashes	Off	FAN7 error
6 Flashes	8 Flashes	Off	FAN8 error
6 Flashes	9 Flashes	Off	FAN9 error
6 Flashes	10 Flashes	Off	FAN10 error
2 Flashes	Off	Off	1W MCU detects scaler stops working
7 Flashes	Off	Off	Case Open
7 Flashes	1 Flash	Off	Lens Open
8 Flashes	Off	Off	DMD error
9 Flashes	Off	Off	Color wheel error
9 Flashes	1 Flash	Off	Phosphor wheel error

### Notes

*In the event of an error, please disconnect the AC power cord and wait for one (1) minute before restarting the projector.*



*If the Power or Light source LEDs are still flashing or the Over Temp LED is lit, Please contact your regional Digital Projection Ltd service center.*

## Vertical offset

The image projected by this projector is at vertical offset relative to the distance between the lens and the screen.

Please refer to the table below to account for the vertical offset when installing the projector.

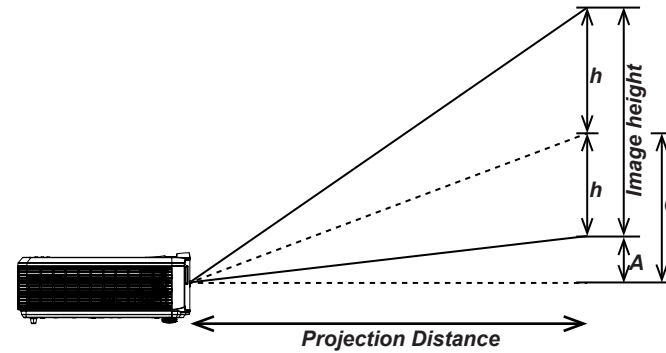

### Notes

### Projection distance and size table

The vertical offset (A) is the distance between the bottom edge of the image and a plane that is parallel with the projector body and measured from the center of the lens.

TR: 0.5, Offset = 110.5%

PROJECTION DISTANCE AND SIZE TABLE							
Distance (m)	0.76	0.85	0.95	1.05	1.15	1.25	1.35
Diagonal (")	70.6	78.9	88.2	97.5	106.8	116.1	125.4
Image Width (mm)	1520.0	1700.0	1900.0	2100.0	2300.0	2500.0	2700.0
Image Height (mm)	950.0	1062.5	1187.5	1312.5	1437.5	1562.5	1687.5
h (mm)	475.0	531.3	593.8	656.3	718.8	781.3	843.8
O (mm)	574.8	642.8	718.4	794.1	869.7	945.3	1020.9
A (mm)	99.8	111.6	124.7	137.8	150.9	164.1	177.2

$$Offset\% = ((O + h) / 2h) * 100$$

$$O = A + h$$

$$h = imageheight / 2$$



## Appendix B: supported signal input modes

### 2D formats

Signal Format	Resolution	H-Sync (KHz)	V-Sync (Hz)	Composite S Video	Component	RGB/BNC (Analog)	HDMI (Digital)	HDBase-T (Digital)
NTSC		15.734	60.0	✓				
PAL/SECAM		15.625	50.0	✓				
VESA	640 x 400	37.9	85.08			✓	✓	✓
	720 x 400	31.5	70.1			✓	✓	✓
	720 x 400	37.9	85.04			✓	✓	✓
	640 x 480	31.5	60.0			✓	✓	✓
	640 x 480	37.9	72.8			✓	✓	✓
	640 x 480	37.5	75.0			✓	✓	✓
	640 x 480	43.3	85.0			✓	✓	✓
	800 x 600	35.2	56.3			✓	✓	✓
	800 x 600	37.9	60.3			✓	✓	✓
	800 x 600	46.9	75.0			✓	✓	✓
	800 x 600	48.1	72.2			✓	✓	✓
	800 x 600	53.7	85.1			✓	✓	✓
	800 x 600	76.3	120.0			✓	✓	✓
	1024 x 576	35.8	60.0			✓	✓	✓
	1024 x 600	37.3	60.0			✓	✓	✓
	1024 x 600	41.5	65.0			✓	✓	✓
	1024 x 768	48.4	60.0			✓	✓	✓
	1024 x 768	56.5	70.1			✓	✓	✓
	1024 x 768	60.0	75.0			✓	✓	✓
	1024 x 768	68.7	85.0			✓	✓	✓
	1024 x 768	97.6	120.0			✓	✓	✓
	1024 x 768	99.0	120.0			✓	✓	✓
	1152 x 864	67.5	75.0			✓	✓	✓
	1280 x 720	45.0	60.0			✓	✓	✓
	1280 x 720	90.0	120.0			✓	✓	✓
	1280 x 768	47.4	60.0			✓	✓	✓
	1280 x 768	47.8	59.9			✓	✓	✓
	1280 x 800	49.7	59.8			✓	✓	✓
	1280 x 800	62.8	74.9			✓	✓	✓

Notes

Signal Format	Resolution	H-Sync	V-Sync	Composite	Component	RGB/BNC	HDMI	HDBase-T
		(KHz)	(Hz)	S Video		(Analog)	(Digital)	(Digital)
VESA	1280 x 800	71.6	84.9			✓	✓	✓
	1280 x 800	101.6	119.9			✓	✓	✓
	1280 x 1024	64.0	60.0			✓	✓	✓
	1280 x 1024	80.0	75.0			✓	✓	✓
	1280 x 960	60.0	60.0			✓	✓	✓
	1280 x 1024	91.1	85.0			✓	✓	✓
	1280 x 960	85.9	85.0			✓	✓	✓
	1360 x 768	47.7	60.0			✓	✓	✓
	1400 x 1050	65.3	60.0			✓	✓	✓
	1440 x 900	55.5	59.9			✓	✓	✓
	1440 x 900	55.9	59.9			✓	✓	✓
	1440 x 900	70.6	75.0			✓	✓	✓
	1600 x1200	75.0	60			✓	✓	✓
	1680 x 1050	64.7	59.9			✓	✓	✓
	1680 x 1050	65.3	60.0			✓	✓	✓
	1920 x 1200	74.0	60.0			✓	✓	✓
	1920 x 1080	67.5	60.0			✓	✓	✓
Apple Macintosh	640 x 480	35.0	66.7			✓	✓	✓
	832 x 624	49.7	74.5			✓	✓	✓
	1024 x 768	60.2	74.9			✓	✓	✓
	1152 x 870	68.7	75.1			✓	✓	✓
SDTV	480i	15.734	60.0		✓		✓	✓
	576i	15.625	50.0		✓		✓	✓
EDTV	576p	31.3	50.0		✓		✓	✓
	480p	31.5	60.0		✓		✓	✓
HDTV	720p	37.5	50.0		✓		✓	✓
	720p	45.0	60.0		✓		✓	✓
	1080i	33.8	60.0		✓		✓	✓
	1080i	28.1	50.0		✓		✓	✓
	1080p	27	24.0		✓		✓	✓
	1080p	28	25.0		✓		✓	✓
	1080p	33.7	30.0		✓		✓	✓
	1080p	56.3	50.0		✓		✓	✓
1080p	67.5	60.0		✓		✓	✓	

Notes

**3D formats**

Resolution	Freq (Hz)	HDMI 1/2	HDBase-T (Digital)	Remarks
1280 x 720	50	✓	✓	Top - and - Bottom
1280 x 720	60	✓	✓	Top - and - Bottom
1280 x 720	50	✓	✓	Frame packing
1280 x 720P	60	✓	✓	Frame packing
1920 x 1080i	50	✓	✓	Side- by-Side (Half)
1920 x 1080i	60	✓	✓	Side- by-Side (Half)
1920 x 1080	24	✓	✓	Top - and - Bottom
1920 x 1080	24	✓	✓	Frame packing
1920 x 1080i	50	✓	✓	Side-by-Side(Half), SBS mode is on
1920 x 1080i	60	✓	✓	Side-by-Side(Half), SBS mode is on
1280 x 720	50	✓	✓	Side-by-Side(Half), SBS mode is on
1280 x 720	60	✓	✓	Side-by-Side(Half), SBS mode is on
1920 x 1080i	50	✓	✓	Top-and-Bottom, TAB mode is on
1920 x 1080i	60	✓	✓	Top-and-Bottom, TAB mode is on
1280 x 720	50	✓	✓	Top-and-Bottom, TAB mode is on
1280 x 720	60	✓	✓	Top-and-Bottom, TAB mode is on
480i		✓	✓	HQFS, 3D format is Frame sequential

**Notes**

## Appendix C: wiring details

### Signal inputs and outputs

#### HDMI

19 way type A connector

1. TMDS Data 2+
2. TMDS Data 2 Shield (Ground)
3. TMDS Data 2-
4. TMDS Data 1+
5. TMDS Data 1 Shield (Ground)
6. TMDS Data 1-
7. TMDS Data 0+
8. TMDS Data 0 Shield (Ground)
9. TMDS Data 0-
10. TMDS Clock+
11. TMDS Clock Shield (Ground)
12. TMDS Clock-
13. CEC
14. not connected
15. SCL (DDC Clock)
16. SCA (DDC Data)
17. DDC/CEC Shield (Ground)
18. +5 V Power
19. Hot Plug Detect

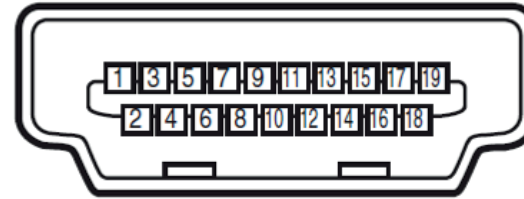

*HDMI: pin view of panel connector*

#### HDBaseT input

RJ45 socket.

1. DATA 0+
2. DATA 0-
3. DATA 1+
4. DATA 2+
5. DATA 2-
6. DATA 1-
7. DATA 3+
8. DATA 3-

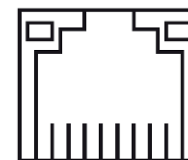

87654321

*HDBase-T*

Notes

**VGA input**

1. Red input
2. Green input
3. Blue input
4. not connected
5. not connected
6. Ground
7. Ground
8. Ground
9. +5 V Power
10. Ground
11. Ground
12. VGA\_SDA
13. H-Sync
14. V-Sync
15. VGA\_SCL
16. Ground

**Control connections****LAN**

RJ45 socket

1. TX+
2. TX-
3. TXC
4. Ground
5. Ground
6. RXC
7. RX+
8. RX-

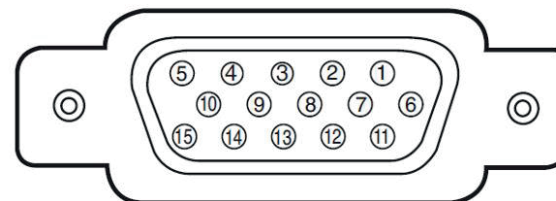
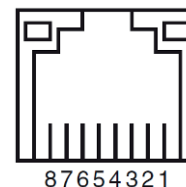
**VGA: pin view of panel connector****LAN: pin view of panel connector****Notes**

 Only one remote connection (RS232 or LAN) should be used at any one time.

**RS232**

9 way D-type connector

1. not connected
2. Received Data (RX)
3. Transmitted Data (TX)
4. not connected
5. Ground
6. not connected
7. Short with pin8
8. Short with pin7
9. not connected

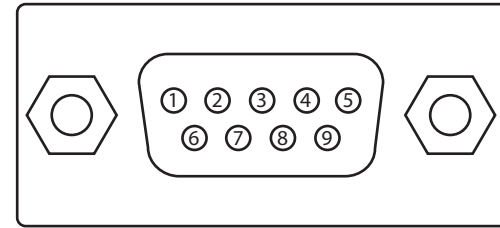
**RS232: pin view of panel male connector****Notes**

**Appendix D: glossary of terms****Notes****1****1080p**

An HDTV resolution which corresponds to 1920 x 1080 pixels (a widescreen aspect ratio of 16:9).

**3****3D active glasses**

Wireless battery-powered glasses with LCD shutters. Synchronization information is communicated to the glasses by means of an infrared (IR) or radio frequency (RF) emitter which is connected to the Sync Out terminal on the projector. IR or RF pulses are transmitted by the emitter to signal when the left eye and right eye images are being displayed. The glasses incorporate a sensor which detects the emitter's signal and synchronises the left and right eye shutters with the projected image.

**3D passive glasses**

Passive glasses do not require a power source to work. Light with left-hand polarisation can pass through the left lens and light with right hand polarisation can pass through the right-hand lens. These glasses are used in conjunction with another device which polarizes the image, such as a ZScreen.

**4****4K-UHD**

The 4K-UHD resolution of 3840 × 2160 is the dominant 4K resolution used in the consumer media and display industries. This resolution has an aspect ratio of 16 :9, with 8,294,400 total pixels.

**A****Adjust lines**

A pattern applied to the image where its edge is to be blended with another image. Adjust lines are used to position the projectors in the array during the edge blend process.

**Anamorphic lens**

A special lens which, when used with the TheaterScope aspect ratio, allows watching 2.35:1 content packed in a 16:9 source.

**Aperture**

The opening of the lens that determines the angle through which light travels to come into focus.

**Aspect ratio**

The proportional relationship between the width and the height of the projected image. It is represented by two numbers separated by a colon, indicating the ratio of image width and height respectively: for example, 16:9 or 2.35:1. Not to be confused with resolution.

**B****Blanking (projection)**

The ability to intentionally turn off, that is, set to black, areas around the edges of the projected image. It is sometimes referred to as “curtains” since it can be used to blank an area of image that literally falls on the curtains at the side of the screen in a movie theater. Usually no image resizing or geometric correction takes place and the “blanked” part of the image is lost. Not to be confused with horizontal and vertical blanking (video signal).

**Blanking (video signal)**

The section of the video signal where there is no active video data. Not to be confused with blanking (projection).

**Blend region**

The area of the image that is to overlap with another image in an edge blend setup. Sometimes called overlapping region.

**Brightness (electronic control)**

A control which adds a fixed intensity value to every pixel in the display, moving the entire range of displayed intensities up or down, and is used to set the black point in the image (see Contrast). In Component Video signals, brightness is the same as luminance.

**Brightness (optical)**

Describes how ‘bright’ an image that is projected onto a screen appears to an observer.

**C****C**

Also known as ‘C’, this is the component, or pair of components, of a Component Video signal which describes color difference information.

**Chrominance**

Also known as ‘C’, this is the component, or pair of components, of a Component Video signal which describes color difference information.

**Color difference**

In Component Video signals, the difference between specified colors and the luminance component. Color difference is zero for monochrome images.

**Color gamut**

The spectrum of color available to be displayed.

**Color temperature**

The position along the black body curve on the chromaticity diagram, normally quoted in Kelvin. It takes into account the preset values for color balance in the service set-up to take up the variations in the prism. The projector allows you to adjust this temperature (i.e. adjust the picture color temperature).



**Component video**

A three-wire or four-wire video interface that carries the signal split into its basic RGB components or luminance (brightness) and two-color difference signals (YUV) and synchronization signals.

**Contrast (electronic control)**

The adjustment of the white point of the image without affecting the black point. This increases the intensity range of the displayed image.

**Contrast (optical)**

The intensity difference between the darkest and lightest areas of the screen.

**Cr, Cb**

Color difference signals used with 'Y' for digital Component Video inputs. They provide information about the signal color. Not to be confused with Pr, Pb.

**Crop**

Remove part of the projected image. Alternatively, fit an image into a frame with a different aspect ratio by removing part of the image. The image is resized so that either its length or its width equals the length or width of the frame, while the other dimension has moved outside the frame; the excess area is then cut out.

**D****Dark time**

The time inserted between frames when using 3D active glasses, to avoid ghosting caused by switching time between left and right eye.

**DDC (Display Data Channel)**

A communications link between the source and projector. DDC is used on the HDMI, DVI and VGA inputs. The link is used by the source to read the EDID stored in the projector.

**Deinterlacing**

The process of converting interlaced video signals into progressive ones.

**DHCP (Dynamic Host Configuration Protocol)**

A network protocol that is used to configure network devices so that they can communicate on an IP network, for example by allocating an IP address.

**DMD™ (Digital Micromirror Device™)**

The optical tool that transforms the electronic signal from the input source into an optical image projected on the screen. The DMD™ of a projector has a fixed resolution, which affects the aspect ratio of the projected image. A Digital Micromirror Device™ (DMD™) consists of moving microscopic mirrors. Each mirror, which acts as a pixel, is suspended between two posts by a thin torsion hinge. It can be tilted to produce either a bright or dark pixel.

**Notes**

## E

---

**Edge blend**

A method of creating a combined image by blending the adjoining edges of two or more individual images.

**Edge tear**

An artifact observed in interlaced video where the screen appears to be split horizontally. Edge tears appear when the video feed is out of sync with the refresh rate of the display device.

**EDID (Extended Display Identification Data)**

Information stored in the projector that can be read by the source. EDID is used on the HDMI, DVI and VGA inputs, allowing the source to automatically configure to the optimum display settings.

**EDTV (Enhanced Definition Television)**

A progressive digital television system with a lower resolution than HDTV.

## F

---

**Field**

In interlaced video, a part of the image frame that is scanned separately. A field is a collection of either all the odd lines or all the even lines within the frame.

**Frame**

One of the many still images displayed in a sequence to create a moving picture. A frame is made of horizontal lines of pixels. For example, a 1920x1080 frame consists of 1080 lines, each containing 1920 pixels. In analog video frames are scanned one at a time (progressive scanning) or split into fields for each field to be scanned separately (interlaced video).

**Frame rate**

The number of frames shown per second (fps). In TV and video, a frame rate is the rate at which the display device scans the screen to “draw” the frame.

**Frame rate multiplication**

To stop low frame rate 3D images from flickering, frame rate multiplication can be used, which increases the displayed frame rate by two or three times

## G

---

**Gamma**

A nonlinear operation used to code and decode luminance. It originates from the Cathode Ray Tube technology used in legacy television sets.

**Ghosting**

An artifact in 3D image viewing. Ghosting occurs when an image intended for one eye is partially seen by the other eye. Ghosting can be removed by optimizing the dark time and sync delay.

## H

---

**HDCP (High-bandwidth Digital Content Protection)**

An encryption scheme used to protect video content.

**HDTV (High Definition Television)**

A television system with a higher resolution than SDTV and EDTV. It can be transmitted in various formats, notably 1080p and 720p.

**Hertz (Hz)**

Cycles per second.

**Horizontal Scan Rate**

The rate at which the lines of the incoming signal are refreshed. The rate is set by the horizontal synchronization from the source and measured in Hertz.

**Hs + Vs**

Horizontal and vertical synchronization.

**Hue**

The graduation (red/green balance) of color (applicable to NTSC).

## I

---

**Interlacing**

A method of updating the image. The screen is divided in two fields, one containing every odd horizontal line, the other one containing the even lines. The fields are then alternately updated. In analog TV interlacing was commonly used as a way of doubling the refresh rate without consuming extra bandwidth.

**Interleaving**

The alternation between left and right eye images when displaying 3D.

## L

---

**LED (Light Emitting Diode)**

An electronic component that emits light.

**Letterboxing**

Black margins at the top and bottom of the image. Letterboxing appears when a wider image is packed into a narrower frame without changing the original aspect ratio.

**Notes**

**Lumen**

A photometric unit of radiant power. For projectors, it is normally used to specify the total amount of emitted visible light.

**Luminance**

Also known as 'Y', this is the part of a Component Video signal which affects the brightness, i.e. the black and white part.

**N**

---

**Noise**

Electrical interference displayed on the screen.

**NTSC (National Television Standards Committee)**

The United States standard for television - 525 lines transmitted at 60 interlaced fields per second

**O**

---

**OSD (on-screen display)**

The projector menus allowing you to adjust various settings.

**Overlapping region**

The area of the image that is to overlap with another image in an edge blend setup. Sometimes called overlapping region.

**P**

---

**PAL (Phase Alternate Line)**

The television system used in the UK, Australia and other countries - 625 lines transmitted at 50 interlaced fields per second.

**Pillarboxing**

Black margins at the left and right of the image. Pillarboxing appears when a narrower image is packed into a wider frame without changing the aspect ratio.

**Pixel**

Short for Picture Element. The most basic unit of an image. Pixels are arranged in lines and columns. Each pixel corresponds to a micromirror within the DMD™; resolutions reflect the number of pixels per line by the number of lines. For example, a 1080p projector contains 1080 lines, each consisting of 1920 pixels.

**Pond of mirrors**

Area around the periphery of the DMD™ containing inactive mirrors. The pond of mirrors may cause artifacts, for example during the edge blending process.

**Notes**

**Pr, Pb**

Color difference signals used with 'Y' for analog Component Video inputs. They provide information about the signal color. Not to be confused with Cr, Cb.

**Primary colors**

Three colors any two of which cannot be mixed to produce the third. In additive color television systems the primary colors are red, green and blue.

**Progressive scanning**

A method of updating the image in which the lines of each frame are drawn in a sequence, without interlacing.

**Pulldown**

The process of converting a 24 fps film footage to a video frame rate (25 fps for PAL/SECAM, 30 fps for NTSC) by adding extra frames. DP projectors automatically carry out reverse pulldown whenever possible.

**R****Resolution**

The number of pixels in an image, usually represented by the number of pixels per line and the number of lines (for example, 1920 x 1200).

**RGB (Red, Green and Blue)**

An uncompressed Component Video standard.

**S****Saturation**

The amount of color in an image.

**Scope**

An aspect ratio of 2.35:1.

**SDTV (Standard Definition Television)**

An interlaced television system with a lower resolution than HDTV. For PAL and SECAM signals, the resolution is 576i; for NTSC it is 480i.

**SECAM (Sequential Color with Memory)**

The television system used in France, Russia and some other countries - 625 lines transmitted at 50 interlaced fields per second.

**Smooth picture**

A feature that can display a higher resolution source than the native resolution of the projector without losing any pixel data.

**SX+**

A display resolution of 1400 x 1050 pixels with a 4:3 screen aspect ratio. (Shortened from SXGA+, stands for Super Extended Graphics Array Plus.)

**Notes**

**Synchronization**

A timing signal used to coordinate an action.

**T**

---

**Test pattern**

A still image specially prepared for testing a projection system. It may contain various combinations of colors, lines and geometric shapes.

**TheaterScope**

An aspect ratio used in conjunction with a special anamorphic lens to display 2.35:1 images packed into a 16:9 frame.

**Throw distance**

The distance between the screen and the projector.

**Throw ratio**

The ratio of the throw distance to the screen width.

**TRC (Throw ratio correction)**

A special number used in calculating throw distances and throw ratios when the image does not fill the width of the DMD™. TRC is the ratio of the DMD™ aspect ratio to the image source aspect ratio:  $TRC = \text{DMD}^{\text{TM}} \text{ aspect ratio} / \text{Source aspect ratio}$ . TRC is only used in calculations if it is greater than 1.

**U**

---

**UXGA**

A display resolution of 1600 x 1200 pixels with a 4:3 screen aspect ratio. (Stands for Ultra Extended Graphics Array.)

**V**

---

**Vertical Scan Rate**

The rate at which the frames of the incoming signal are refreshed. The rate is set by the vertical synchronization from the source and measured in Hertz.

**Vignetting**

Optical cropping of the image caused by the components in the projection lens. This can happen if too much offset is applied when positioning the image using the lens mount.

**Vista**

An aspect ratio of 1.66:1.

**W**

---

**WUXGA**

A display resolution of 1920 x 1200 pixels with a 16:10 screen aspect ratio. (Stands for Widescreen Ultra Extended Graphics Array.)

**Y**

---

**Y**

This is the luminance input (brightness) from a Component Video signal.

**YUV**

Color difference signals used with 'Y' for analog Component Video inputs. They provide information about the signal color. Not to be confused with Cr, Cb.

**Z**

---

**ZScreen**

A special kind of light modulator which polarizes the projected image for 3D viewing. It normally requires that images are projected onto a silver screen. The ZScreen is placed between the projector lens and screen. It changes the polarization of the projected light and switches between left- and right-handed circularly polarized light at the field rate.

**Notes**

# DIGITAL PROJECTION

A Delta Associate Company

## Contact Information:

### Europe

Digital Projection Limited  
Greenside Way, Middleton,  
Manchester, M24 1XX, UK  
*Registered in England No.*  
2207264  
*Registered Office: As Above*  
Tel: (+44) 161 947 3300  
Fax: (+44) 161 684 7674  
enquiries@digitalprojection.co.uk  
service@digitalprojection.co.uk  
www.digitalprojection.co.uk

### North America

Digital Projection Inc.  
55 Chastain Road, Suite 115,  
Kennesaw, GA 30144, USA  
Tel: (+1) 770 420 1350  
Fax: (+1) 770 420 1360  
powerinfo@digitalprojection.com  
www.digitalprojection.com

### China

Digital Projection China  
中国北京市朝阳区芍药居北  
里101号世奥国际中心A座2301  
室(100029)  
Rm A2301, ShaoYaoJu 101 North  
Lane, Shi Ao International Center,  
Chaoyang District, Beijing 100029,  
PR CHINA  
Tel: (+86) 10 84888566  
Fax: (+86) 10 84888566-805  
techsupport@dp-china.com.cn  
www.dp-china.com.cn

### Dubai

Digital Projection FZE  
Unit B4, Light Industrial Units 4,  
Silicon Oasis, Dubai, UAE  
Tel: +971 43300800  
enquiries@digitalprojection.co.uk  
www.digitalprojection.com

### Japan

Digital Projection Japan  
〒105-0012 東京都港区芝大門  
2-1-14  
2-1-14 Shibadaimon, Minato-ku,  
Tokyo, Japan 105-0012  
japan@digitalprojection.co.uk  
www.digitalprojection.com/jp

### Taiwan

Digital Projection Taiwan  
186 Ruey Kuang Rd, Neihu  
District, Taipei, 114 Taiwan  
Tel: +886-8797-2088 x8854  
Taiwan@digitalprojection.co.uk

### Korea

Digital Projection Korea  
1511, Byucksan Digital Valley 6-  
cha, Gasan-dong, Geumcheon-  
gu, Seoul, Korea  
Tel: (+82) 2 515 5303 #1417  
Korea@digitalprojection.co.uk

### India

Digital Projection India  
Plot-43, Sector-35, HSIIDC,  
Gurgaon Haryana -122001  
Tel: +91-124-4874900#4275  
india@digitalprojection.co.uk